

TM 11-5820-510-12

DEPARTMENT OF THE ARMY TECHNICAL MANUAL

**OPERATOR AND
ORGANIZATIONAL MAINTENANCE MANUAL**

RADIO SET AN/PRC-41

This copy is a reprint which includes current
pages from Changes 1 and 2.

**HEADQUARTERS, DEPARTMENT OF THE ARMY
JANUARY 1964**

WARNING

In fixed installations, when using Power Supply PP-3700/PRC-41, be careful when working on the 115- or 230-volt terminals. Serious injury or death may result from contact with these terminals.

DON'T TAKE CHANCES!

FSN QTY Nomenclature, part No., and mfr code

NOTE

Dry batteries shown are used with the equipment but are not considered part of the equipment. They will not be preshipped automatically but are to be requisitioned in quantities necessary for the particular organization in accordance with SB 11-6.

5985-9564991	1	Antenna AS-1404/PRC-41: Stub; 225 to 400 mc; omnidirectional; mast mounted.
6140-889-1027	3	Battery, Storage, BB451/U: 24 volts, 25 amp/hr capacity; nonspillable; 2 unthreaded socket type terminals
5965-163-9947	1	Handset H-33F/PT: 300 ohms impedance; battery powered; waterproof; operated by push-to-talk switch; includes retractable cord and connector U-161/U 1
5820-82-4066	1	Harness, Electrical Equipment: Comprises 1 rucksack frame and I pack harness which consists of waist and back straps for carrying the rucksack frame and bags for carrying handset H-33F/PT and antenna AS-1404/PRC-41 Receiver-Transmitter RT-695/PRC-41; Frequency range 225.0 mc to 399.99 mc, 1750 channels spaced 100 kc apart; transmitter amplitude modulated, 3 watts power output, 1 minute duty cycle for transmission, power requirements 26.5 volts dc and 2.9 amps or 115 volts ac or 230 volts ac at 50-400 cps and 135 watts; receiver audio output 450 mw into 300 ohm load with 90% amplitude modulation, audio distortion less than 10% at 50 mw output, 9 minute duty cycle for reception; complete separate guard receiver except audio amplifier.

Add paragraph 1-1.5 after paragraph 1-1.4.

Page 8-1. Appendix III is superseded by the following:

1-1.5. Running Spares.

FSN	Qty	Item
6240-155-7836	2	Lamp, Incandescent Midget: flange base; 28 volts, 0.04 amp. MIL type MS25237-327

**APPENDIX III
BASIC ISSUE ITEMS LIST**

Section I. INTRODUCTION

1. Scope

This appendix lists only basic issue items required by the crew/operator for installation, operation, and maintenance of Radio Set AN/PRC 41.

2. General

The basic issue items list (Section II) is a list, in alphabetical sequence, of items which are furnished with, and which must be turned in with the end item.

3. Explanation of Columns

The following provides an explanation of columns

found in the tabular listings.

a. Illustration. Not applicable.

b. Federal stock number. Indicates the Federal stock number assigned to the item and will be used for requisitioning purposes.

c. Part Number. Indicates the primary number used by the manufacturer (individual, company, firm, corporation, or Government activity), which controls the design and characteristics of the item by means of its engineering drawings, specifications standards, and inspection requirements, to identify an item or range of items.

d. Federal Supply Code for Manufacturer

(FSCM). The FSCM is a 5-digit numeric code used to identify the manufacturer, distributor, or Government agency, etc. and is identified in SB 708-42.

e. Description. Indicates the Federal item name and a minimum description required to identify the item.

f. Unit of Measure (U/M). Indicates the standard of basic quantity of the listed item as used in performing the actual maintenance function. This measure is

expressed by a two-character alphabetical abbreviation, (e.g., ea. in., pr, etc.). When the unit of measure differs from the unit of issue, the lowest unit of issue that will satisfy the required units of measure will be requisitioned.

g. Quantity Furnished with Equipment (Basic Issue Items Only). Indicates the quantity of the basic issue item furnished with the equipment

Section II BASIC ISSUE ITEMS LIST

(1) Illustration		(2) Federal stock number	(3) Part number	(4) FSCM	(5) Description Usable on code	(6) Unit of meas	(7) Qty furn with equip
(A) Fig no.	(B) Item No.						
		5820-763-1330			CASE, RADIO SET, CY-3883/PRC-41, 34 INCHES LONG, 22 INCHES WIDE, 13 INCHES HIGH, PROVIDES HOUSING FACILITIES FOR COMPONENTS OF RADIO SET AN/PRC-41	EA	1

By Order of the Secretary of the Army:

CREIGHTON W. ABRAMS
General, United States Army
Chief of Staff

Official:

VERNE L. BOWERS
Major General, United States Army
The Adjutant General

Distribution:

To be distributed in accordance with DA Form 12-51 (qty rqr block no. 333), Operator requirements for AN/PRC-41.

GP O 942 896

Operator and Organizational Maintenance Manual

RADIO SET AN/PRC.-.41

CHANGE

}

No. 1

HEADQUARTERS
DEPARTMENT OF THE ARMY
WASHINGTON, D. C., 23 November 1964

TM 11 5820-510-12, 10 January 1964 is changed as follows:

After page 8-0, Appendix. Designate appendix as appendix I.
Add to the references

TM 11-5965-202-15P Operator, Organizational, Field and Depot Maintenance Repair Parts and Special Tool List,
and Maintenance Allocation Chart: Handsets H-33E/PT and H-33F/PT.

Add Appendixes II and III after APPENDIX I.

APPENDIX II MAINTENANCE ALLOCATION

Section I. INTRODUCTION

1. General

a. This section assigns maintenance functions to be performed on components, assemblies, and subassemblies by the lowest appropriate maintenance category.

b. Columns in the maintenance allocation chart are as follows:

(1) *Part or component.* This column shows only the nomenclature or standard item name. Additional descriptive data are included only where clarification is necessary to identify the component. Components, assemblies, and subassemblies are listed in top-down order. That is, the assemblies which are part of a component are listed immediately below that component, and the subassemblies which are part of an assembly are listed immediately below that assembly. Each generation breakdown (components, assemblies, or subassemblies) is listed in disassembly order or alphabetical order.

(2) *Maintenance function.* This column indicates the various maintenance functions allocated to the categories.

(a) Service. To clean, to preserve, and to replenish lubricants.

(b) Adjust. To regulate periodically to prevent malfunction.

(c) Inspect. To verify serviceability and to detect incipient electrical or mechanical failure by scrutiny.

(d) Test. To verify serviceability and to detect incipient electrical or mechanical failure by use of special equipment such as gages, meters, etc.

(e) Replace. To substitute serviceable components, assemblies, or subassemblies, for unserviceable components, assemblies, or subassemblies.

(f) Repair. To restore an item to serviceable condition through correction of a specific failure or unserviceable condition. This function includes but is not limited to welding, grinding, riveting, straightening, and replacement of parts other than the trial and error replacement of running spare type items such as fuses, lamps, or electron tubes.

(g) Align. To adjust two or more components of an electrical system so that their functions are properly synchronized.

(h) Calibrate. To determine, check, or rectify the graduation of an instrument,

weapon, or weapons system, or components of a weapons system.

(i) *Overhaul*. To restore an item to completely serviceable condition as prescribed by serviceability standards. This is accomplished through employment of the technique of "Inspect and Repair Only as Necessary" (IROAN). Maximum utilization of diagnostic and test equipment is combined with minimum disassembly of the item during the overhaul process.

(j) *Rebuild*. To restore an item to a standard as near as possible to original or new condition in appearance, performance, and life expectancy. This is accomplished through the maintenance technique of complete disassembly of the item, inspection of all parts or components, repair or replacement of worn or unserviceable elements using original manufacturing tolerances and/or specifications and subsequent reassembly of the item.

(3) (Operator, organizational, direct support, general support, and depot). The symbol X indicates the categories responsible for performing that particular maintenance operation, but does not necessarily indicate that repair parts will be stocked at that level. Categories higher than those marked by X are authorized to perform the indicated operation.

(4) *Tools required*. This column indicates codes test assigned to each individual tool equipment test equipment, and maintenance equipment referenced. The grouping of codes in this column of the maintenance allocation chart indicates the tool, test, and maintenance equipment required to perform the maintenance function.

(5) *Remarks*. Entries in this column will be utilized when necessary to clarify any of the data cited in the preceding columns.

c. Columns in the allocation of tools for maintenance functions are as follows:

(1) *Tools required for maintenance functions*. This column lists tools, test, and maintenance equipment required to perform the maintenance functions.

(2) (Operator, organizational, direct support, general support, and depot). The dagger (†) symbol indicates the categories normally allocated the facility.

(3) *Tool code*. This column lists the tool code assigned.

2. Maintenance by Using Organizations

When this equipment is used by signal services organizations organic to theater headquarters or communication zones to provide theater communications, those functions allocated up to and including general support are authorized to the organization operating this equipment.

Section II. MAINTENANCE ALLOCATION CHART

(1)	(2)	(3)	(4)	(5)	(6)	(7)	(8)	(9)
PART OR COMPONENT	MAINTENANCE FUNCTION	1ST ECH	2ND ECH	3RD ECH	4TH ECH	5TH ECH	TOOLS REQUIRED	REMARKS
RADIO-SET AN/PRC-41	service adjust		X X				17 17 15	Plus shop facilities
	inspect test	X	X	X			7,14,17 2, 3, 9,10,14,15 18	
	replace repair align 15,18	X		X X		X	2, 5, 6, 8, 11, 12 11,15 18 1 2 4,5,6,8,11 12,13 13,15,16,18 17 15 2,3,6,9,10,11,	
	overhaul				X		2 4 5,6,8,9;11 13,15,18 15,16	
ANTENNA	inspect replace repair		X X	X			15	
CASE, TRANSIT	inspect replace repair		X X			X	15	
BATTERY BB-451/U	service inspect test replace		X X X	X			7	

(1)	(2)	(3)	(4)	(5)	(6)	(7)	(8)	(9)
PART OR COMPONENT	MAINTENANCE FUNCTION	1ST ECH	2ND ECH	3RD ECH	4TH ECH	5TH ECH	TOOLS REQUIRED	REMARKS
AN/PRC-41 (continued)								
HEADSET H-33F/FT	inspect replace repair		X X			X		See seperate MAC
RECEIVER-TRANSMITTER RT-695/PRC-41	service adjust inspect test replace repair align overhaul	X	X X X X	X X X		X X	17 17 13 7,14,17 2,3,9,10,14,15, 18 2,5,6,8,11,12, 14,15,18 1,2,4,6,8,11, 12,13,15,16,18 17 15,16 2,3,6,9,10,11, 13,18 3,4,5,6,8,9,11, 12,15,18 15,16	Plus shop facilities
AMPLIFIER, AUDIO AF 1A4	service adjust inspect test replace repair overhaul	+	X X X	X X X X		X X	13 2,9,15,18 15 11,17 2,9,14,15,18 2,8,9,14,15,18 1,2,8,9,13,15, 18 17 15 15,16	Plus shop facilities

(1) PART OR COMPONENT	(2) MAINTENANCE FUNCTION	(3) 1 ST ECH	(4) 2 ND ECH	(5) 3 RD ECH	(6) 4 TH ECH	(7) 5 TH ECH	(8) TOOLS REQUIRED	(9) REMARKS
AN/PRC-41 (continued)								
AMPLIFIER IF 1A2	service			X			15	
	inspect			X			13	
	test			X			3,6,9,10,14,15, 18	
					X		4,5,6,8,14,15, 18	
						X	4,5,6,8,13,15 18	
	replace			X			15	
	repair			X			15	
	align						3,6,9,10,15,18	
	overhaul					X	15,16	Plus shop facilities
AMPLIFIER IF 1AS	service			X			15	
	inspect						15	
	test			X			3,6,9,10,14,15, 18	
					X		4,5,6,8,14,15, 18	
						X	4,5,6,8,13,15 18	
	replace			X			15	
	repair			X			15	
	align			X			3,6,9,10,15,18	
	overhaul					X	15,16	plus shop facilities

(1)	(2)	(3)	(4)	(5)	(6)	(7)	(8)	(9)
PART OR COMPONENT	MAINTENANCE FUNCTION	1ST ECH	2ND ECH	3RD ECH	4TH ECH	5TH ECH	TOOLS REQUIRED	REMARKS
AN/PRC-41 (continued)								
AMPLIFIER RF 1A8	service			X			15	
	inspect			X			15	
	test			X			3,6,9,10,11 14,15,18	
				X			4,5,6,8,11,12, 14,15,18	
						X	4,5,6,8,11,12, 13,15,18	
	replace			X			15	
	repair			X			13	
	align			X			3,6 9,10,11 15,18	
	overhaul					X	15,16	Plus shop facilities
	CASE, RECEIVER-TRANSMITTER	inspect		X				
replace				X				
GENERATOR SPECTRUM 1A5	service			X			13	
	inspect			X			15	
	test			X			9,14,18	
	overhaul					X	13,16	Plus shop facilities
MODULATOR RF 1A6	service			X			13	
	adjust			X			15	
	inspect			X			15	
	replace			X			15	
	repair			X			15	
	overhaul			X			15,16	

(1)	(2)	(3)	(4)	(5)	(6)	(7)	(8)	(9)
PART OR COMPONENT	MAINTENANCE FUNCTION	1ST ECH	2ND ECH	3RD ECH	4TH ECH	5TH ECH	TOOLS REQUIRED	REMARKS
AN/PRC-41(continued)								
POWER SUPPLY 1A1	service adjust		X	X			13 7,17	
	inspect test		X	X			9,15 15 11,17	
	replace repair overhaul		X	X	X	X	9,14,15 8,14,15,18 8,13,15,18	
RECEIVER RADIO 1A7	service adjust		X				17	Plus shop facilities
	inspect test	X	X	X:			17 15	
			X		X		7,14,17 2,3,9,10,14,15	
					X		13 2,5,6,8,11,12	
	replace repair align		X	X		X	14,15,18 1,2,4,5,6,8,11	
	overhaul				X	X	12,13,15,16,18 17 13 2,3,6,9,10,11, 15,18 2,4,5,6,8,9,11 13,18	Plus shop facilities
						X	15,16	

(1)	(2)	(3)	(4)	(5)	(6)	(7)	(8)	(9)
PART OR COMPONENT	MAINTENANCE FUNCTION	1ST ECH	2ND ECH	3RD ECH	4TH ECH	5TH ECH	TOOLS REQUIRED	REMARKS
AN PRC -41(continued)								
RECEIVER-TRANSMITTER SUBASSEMBLY 1A9	adjust			service			X 13	
	inspect			X			15	
	replace			X			15	
	repair			X			15	
	overhaul					X	15,16	Plus shop facilities
MECHANICAL DRIVE ASSEMBLY 1A9	service			X			15	
	replace				X		15	
	repair				X		15	
	overhaul					X	15,16	Plus shop facilities

TAGO 6635-A

Section III. ALLOCATION OF TOOLS FOR MAINTENANCE FUNCTIONS

TOOLS REQUIRED FOR MAINTENANCE FUNCTIONS	O/C	ECHELON				TOOL CODE	REMARKS
		O	DS	GS	D		
AN/PRC-41 (continued)							
ANALYZER, SPECTRUM TS-723/U					†	1	
AUDIO OSCILLATOR TS-382/U			†	†	†	2	
FREQUENCY METER AN/URM-32			†			3	
FREQUENCY METER AN/URM-79				†	†	4	
FREQUENCY METER AN/URM-81				†	†	5	
GENERATOR, SIGNAL SG-213/U			†	†	†	6	
MULTIMETER AN/URM-105		†				7	
MULTIMETER ME-26/U				†	†	8	
MULTIMETER TS-352/U			†	†	†	9	
POWER SUPPLY PP-1243/U			†			10	P/O AN/URM-32
RF SIGNAL GENERATOR SET AN/URM-25			†	†	†	11	
RF WATTMETER AN/YRM-120				†	†	12	
TEST SET, ELECTRON TUBE TV-2/U					†	13	
TEST SET ELECTRON TUBE TV-7/U		†	†	†		14	
TOOL KIT, RADAR & RADIO REPAIRMAN TK-87/U			†	†	†	15	
TOOL KIT, SUPPLEMENTARY RADAR & RADIO REPAIR TK-88/U				†	†	16	
TOOL KIT, RADIO REPAIR TK-115/G		†				17	
VOLTMETER, ME-30/U			†	†	†	18	

APPENDIX III

BASIC ISSUE ITEMS LIST

Section I. INTRODUCTION

1. General

This appendix lists items supplied for initial operation and for running spares. The list includes tools, parts, and material issued as part of the major end item. The list includes all items authorized for basic operator maintenance of the equipment. End items of equipment are issued on the basis of allowances prescribed in equipment authorization tables and other documents that are a basis for requisitioning. This equipment is combat essential.

2. Columns

Columns are as follows:

- a. Federal Stock Number.* This column lists the 11-digit Federal stock number.
- b. Designation By Model.* Not used.

c. Description. Nomenclature or the standard item name and brief identifying data for each item are listed in this column. When requisitioning, enter the nomenclature and description.

d. Unit of Issue. The unit of issue is each unless otherwise indicated and is the supply term by which the individual item is counted for procurement, storage, requisitioning, allowances, and issue purposes.

e. Expendability. Nonexpendable items are indicated by NX. Expendable items are not annotated.

f. Quantity authorized. Under "Items Comprising an Operable Equipment", the column lists the quantity of items supplies for the initial operation of the equipment. Under "Running Spare Items" the quantities listed are those issued initially with the equipment as spare parts. The quantities are authorized to be kept on hand by the operator for maintenance of the equipment.

g. Illustrations. Not used.

Section II. FUNCTIONAL PARTS LIST

FEDERAL STOCK NUMBER	DESIGNATION BY MODEL				DESCRIPTION	UNIT OF ISSUE	EXP	QTY AUTH	ILLUSTRATION	
									FIGURE NO.	ITEM NO
Ord thru AGC					RADIO SET AN/PRC-41: Portable manpack; amplitude modulated; frequency range 225 0 mc to 399.99 mc; battery powered in manpack operation;; adaptable to fixed or vehicular operation by means of Installation Kit MK-706/PRC-41.					
5985-956-4991					ITEMS COMPRISING AN OPERABLE EQUIPMENT TECHNICAL MANUAL TM 11-5820-510-12			2		
6140-889-1027					ANTENNA AS-1404/PAC-41: Stub; 225 to 400 mc; omnidirectional; mast mounted		NX	1		
					BATTERY, STORAGE, BB-451/U: 24 volts, 25 amp/hr capacity; non-spillable; 2 unthreaded socket type terminals		NX	3		
					CASE, RADIO SET, CY-3883/PRC-41: 34 inches long, 22 inches wide 13 inches high; provides housing facilities for components of Radio Set AN/PRC-41.		NX	1		
5965-163-9947					HANDSET H-33F/PT: 300 ohms impedance; battery powered; waterproof operated by push-to-talk switch; includes retractable cord and connector U-161/U		NX	1		
					HARNES, ELECTRICAL EQUIPMENT: Comprises 1 rucksack frame, and 1 pack harness which consists of waist and back straps for carrying the rucksack frame and bags for carrying handset N-33F/PT and antenna AS-1404/PRC-41		NX	1		
					RECEIVER-TRANSMITTER RT-695/PRC-41: Frequency range 225.0 mc to 399.99 mc, 1750 channels spaced 100 kc apart; transmitter amplitude modulated, 3 watts power output, 1 minute duty cycle for transmission, power requirements 26.5 volts dc and 2.9 amps or 115 volts ac or 230 volts ac at 50-400 cps and 135 watts receiver audio output 450 mw into 300 ohm load with 90% amplitude modulation, audio distortion less than 10% at 50 mw output, 9 minute duty cycle for reception; complete separate guard receiver except audio amplifier.		NX	1		
					RUNNING SPARE ITEMS					
6240-155-7836					LAMP INCANDESCENT: Midget; flange base 28 volts, 0.04 amp. MIL type MS25237-327.			2		

By Order of the Secretary of the Army:

HAROLD K. JOHNSON,
General, United States Army,
Chief of Staff

Official:

J. C. LAMBERT,
Major General, United States Army,
The Adjutant General.

Distribution:

Active Army:

USASA (2)	USACDCCEA (Monmouth Ofc)	USATC AD (2)
CNGB (1)	(1)	USATC Armor (2)
CC-E (7)	USACDCOA (1)	USATC Engr (2)
CofT (1)	USACDCQMA (1)	USATC Inf (2)
CofEngrs (1)	USACDCTA (1)	USASTC (2)
TSG (1)	USACDCADA (1)	WRAMC (1)
CofSptS (1)	USACDCARMA (1)	Army Pi Cen (2)
USAARMBD (2)	USACDCAVNA (1)	WSMR (5)
USAARTYBD (2)	USACDCARTYA (1)	USA Tml Comd (1)
USCONARC (6)	USACDCSWA (1)	Army Tml (1) except OART (5)
USAMC (5)	Svc Colleges (2)	POE (1)
ARADCOM(2)	Br Svc Sch (2) except	Sig Fld Maint Shops (2)
ARADCOM Rgn (2)	USAAMS (20)	AMS (1)
OS Maj Comd (3)	USAIS, USAARMS, USASESCS	USAERDAA (2)
LOGCOMD (2)	(20)	USAERDAW (13)
USAECOM (7)	GENDEP (OS) (2)	Units org under fol TOE's (2 Copies
USAMICOM (4)	Sig Sec, GENDEP (OS) (6)	each except as indicated):
USASMC (2)	Sig Dep (OS) (12)	11-16
MDW (1)	Army Dep (2) except	11-57
Armies (2)	LXAD (14)	11-97
Corps (2)	SAAD (30)	11-98
USAC (3)	TOAD (14)	11-117
11th Air Assault Div (3)	FTWOAD (10)	11-155
Instl (2) except	LEAD NAAD (6)	11-157
Ft Monmouth (63)	SHAD (3)	11-500 (AA-AE) (4)
Ft Hancock (4)	SVAD (5)	11-557
Ft Gordon (5)	CHAD (3)	11-587
Ft Huachuca (10)	ATAD (4)	11-592
USACDCEA (1)	USASCC (4)	11-597
USACDCCBRA (1)		

NG: None.

USAR None.

For explanation of abbreviations used, see AR 320-50

TECHNICAL MANUAL)
)
 NO. 11-5820-510-12)

HEADQUARTERS
 DEPARTMENT OF THE ARMY
 WASHINGTON, D. C., 10 January 1964

Operator and Organizational Maintenance Manual
 RADIO SET AN/PRC-41
 SECTION 1 - GENERAL INFORMATION

Paragraph	Page
1-1. Scope	1-1
1-1.1. Index of Publications	1-1
1-1.2. Forms and Records	1-1
a. Reports of Maintenance and Unsatisfactory Equipment	1-1
b. Report of Damaged or Improper Shipment	1-1
c. Reporting of Equipment Manual Improvements	1-1.1
1-2. Equipment Supplied	1-1.1
1-3. Equipment Required but not Supplied	1-6
1-4. General Description	1-8
1-5. Description of Units	1-8
a. General	1-8
b. Radio Set AN/PRC-41	1-8
(1) Radio Set Case CY-3883/PRC-41	1-8
(2) Radio Receiver-Transmitter RT-695/PRC-41	1-8
(3) Receiver-Transmitter Case CY-3884/PRC-41	1-8
(4) Storage Battery BB-451/U	1-8
(a) General	1-8
(b) Construction	1-8
(c) Cells	1-8
(d) Charge Retention (Dry)	1-9
(e) Activation	1-9
(f) Charge Acceptance	1-9
(g) Storage	1-10
(5) Antenna AS-1404/PRC-41	1-10
(6) Handset B-33E/PT	1-10
(7) Rucksack Frame	1-10
c. Radio Set Accessory Kit MK-706/PRC-41	1-10
(1) Electronic Equipment Case CY-3885/PRC-41	1-10
(2) Power Supply PP-3700/PRC-41	1-10
(3) Mountings MT-2976/PRC-41 and MT-2977/PRC-41	1-10
(4) Antenna AS-1405/PRC-41 and Accessories	1-10
(5) Antenna Mounting Bracket	1-12
(6) Radio Frequency Cable Assembly CG-55G/U	1-12
(7) Power Electric Cable Assembly CX-8686/PRC-41	1-12
(8) Power Electric Cable Assembly CX-8687/PRC-41	1-12
(9) Special Purpose Electrical Cable Assembly CX-8688/PRC-41	1-13
(10) D-C Adapter Cable	1-13
(11) Maintenance Cable Kit	1-13
(12) Tool Kit	1-13
1-6. Reference Data	1-18
a. Power Requirements	1-18
b. Frequency Data	1-18
c. Transmitter Data	1-18
d. Receiver Data	1-18
e. Guard Receiver Data	1-18
1-7. Factory or Field Changes.....	1-19
1-8. Preparation for Reshipment	1-19

TABLE OF CONTENTS (cont)

Paragraph Page

SECTION 2 - INSTALLATION

2-1. Unpacking and Handling	2-0
2-2. Power Provisions and Distribution	2-0
a. Power Provisions	2-0
b. Power Distribution	2-0
2-3. Site Selection	2-0
2-4. Installation Requirements	2-0
a. Man-Pack Installation	2-0
(1) Stowing Equipment for Man-Pack Operation	2-1
(2) Storage Battery BB-451/U Exchange	2-4
b. Fixed Station Installation	2-4
(1) Antenna Mast Installation	2-5
c. Vehicular or Aircraft Installation	2-5
(1) Mounting and Power Considerations	2-5
(2) Antenna Considerations	2-7
d. Automatic Relay Installation	2-7
(1) Description of Automatic Relay Installation	2-7
2-5. Cable Assemblies	2-8
a. General	2-8
b. Fabrication of Special Cables	2-11
(1) 230-Volt Power Cable	2-11
(2) Radio Frequency Coaxial Cable	2-11
2-6. Inspection and Adjustment	2-11
2-7. Interference Reduction	2-11

SECTION 3 - OPERATION

3-1. Preparation for use	3-0
3-2. Controls, Connectors, and Indicator	3-0,3-1
3-3. Operating Procedures	3-2
a. Main Receiver Reception	3-2
b. Guard Receiver Reception	3-2
c. Transmission	3-2
d. Automatic Relay Operation	3-2

SECTION 7 - PREVENTIVE MAINTENANCE

7-1. Preventive Maintenance Instructions	7-0
a. Systematic Care	7-0
b. Preventive Maintenance Checks and Services	7-0
c. Preventive Maintenance Checks and Services Periods	7-0
7-2. Daily Preventive Maintenance Checks and Services Chart	7-1,7-2
7-3. Cleaning	7-3
7-4. Quarterly Maintenance	7-3
7-5. Quarterly Preventive Maintenance Checks and Services Periods	7-3
7-6. Quarterly Preventive Maintenance Checks and & Services Chart	7-4,7-5
7-7. Cleaning and Touchup Painting Instructions	7-6

TABLE OF CONTENTS (cont)

Paragraph		Page
	SECTION 8 - TROUBLESHOOTING	
8-1. Operator's Troubleshooting		8-0
a. Battery Operation		8-0
b. Ac Operation		8-0
8-2. Organizational Troubleshooting		8-0
Appendix--References		

LIST OF ILLUSTRATIONS

Figures	Page	Figure	Page
SECTION 1 - GENERAL INFORMATION		SECTION 2 - INSTALLATION (Cont)	
1-1.	Radio Set AN/PRC-41 Operating Configurations 1-0	2-4.	Radio Set AN/PRC-41, Man-Pack Installation 2-4
1-2.	Radio Set AN/PRC-41, Equipment Contents of Radio Set Case CY-3883/PRC -41 1-2	2-5.	Assembly of Strappings of Rucksack Frame for Man-Pack Operation 2-5
1-3.	Radio Set Accessory Kit MK-706/ PRC-41, Accessory Contents of Electronic Equipment Case CY-3885/PRC-41 1-4	2-6.	Radio Set AN/PRC-41, Fixed Station Installation 2-6
1-4.	Radio Receiver-Transmitter RT-695/PRC-41, Receiver - Transmitter Case CY-3884/ PRC-41 Displaced 1-9	2-7.	Radio Set AN/PRC-41, Vehicular Installation 2-6
1-5.	Storage Battery BB-451/U, Oblique View 1-9	2-8.	Principle of Automatic Relay Operation 2-7
1-6.	Radio Set AN/PRC-41, Man-Pack Operation Configuration 1-11	2-9.	Automatic Relay Operation, Simplified Schematic Diagram 2-9
1-7.	Power Supply PP-3700/PRC-41, Oblique View 1-13	2-10.	230-Volt Power Cable, Fabrication Diagram 2-11
1-8.	Mounting MT-2976/PRC-41 and MT-2977/PRC-41, Oblique Views 1-12	2-11.	Radio Frequency Coaxial Cable, Fabrication Diagram 2-12
1-9.	Antenna AS-1405/PRC-41, Mast AB-777/PRC-41, and Accessories 1-13	2-12.	Assembly of Type RG-8/U Connector 2-12
1-10.	Antenna Mounting Bracket 1-14	2-13.	Radio Receiver-Transmitter RT-695/PRC-41, Outline and Mounting Dimensions 2-13
1-11.	Cable Assemblies 1-14	2-14.	Power Supply PP-3700/PRC-41, Outline and Mounting Dimensions 2-14
1-12.	Maintenance Cable Kit 1-16	2-15.	Storage Battery BB-451/U, Outline and Mounting Dimensions 2-15
1-13.	Tool Kit 1-17	2-16.	Mounting MT-2976/PRC-41, Outline and Mounting Dimensions 2-16
	SECTION 2 - INSTALLATION	2-17.	Mounting MT-2977/PRC-41, Outline and Mounting Dimensions 2-17
2-1.	Location of Items of Radio Set AN/PRC-41 in Radio Set Case CY-3883/PRC-41 2-1	SECTION 3 - OPERATION	
2-2.	Location of Items of Radio Set Accessory Kit MK-706/PRC-41 in Electronic Equipment Case CY-3885/PRC-41 2-2	3-1.	Radio Receiver-Transmitter RT-695/PRC-41, Front Panel Controls 3-0
2-3.	Source of Power Configurations of Radio Receiver-Transmitter RT-695/PRC-41 2-3	3-2.	Radio Receiver-Transmitter RT-695/PRC-41 and Power Supply PP-3700/PRC-41, Rear View, Fuse Location 3-4

LIST OF TABLES

Table.	Page	Table	Page
SECTION 1 - GENERAL INFORMATION		SECTION 2 - INSTALLATION	
1-1.	Radio Set AN/PRC-41, Equipment Supplied 1-1	2-1.	Cables Supplied with Radio Set Accessory Kit MK-706/PRC-41 2-8
1-2.	Radio Set Accessory Kit MK-706/ PRC-41, Equipment Supplied 1-3	SECTION 3 - OPERATION	
1-3.	Equipment Required but not Supplied 1-6	3-1.	Control, Indicator, or Connector 3-2
1-4.	Contents of Maintenance Cable Kit 1-5		
1-5.	Contents of Tool Kit 1-17		

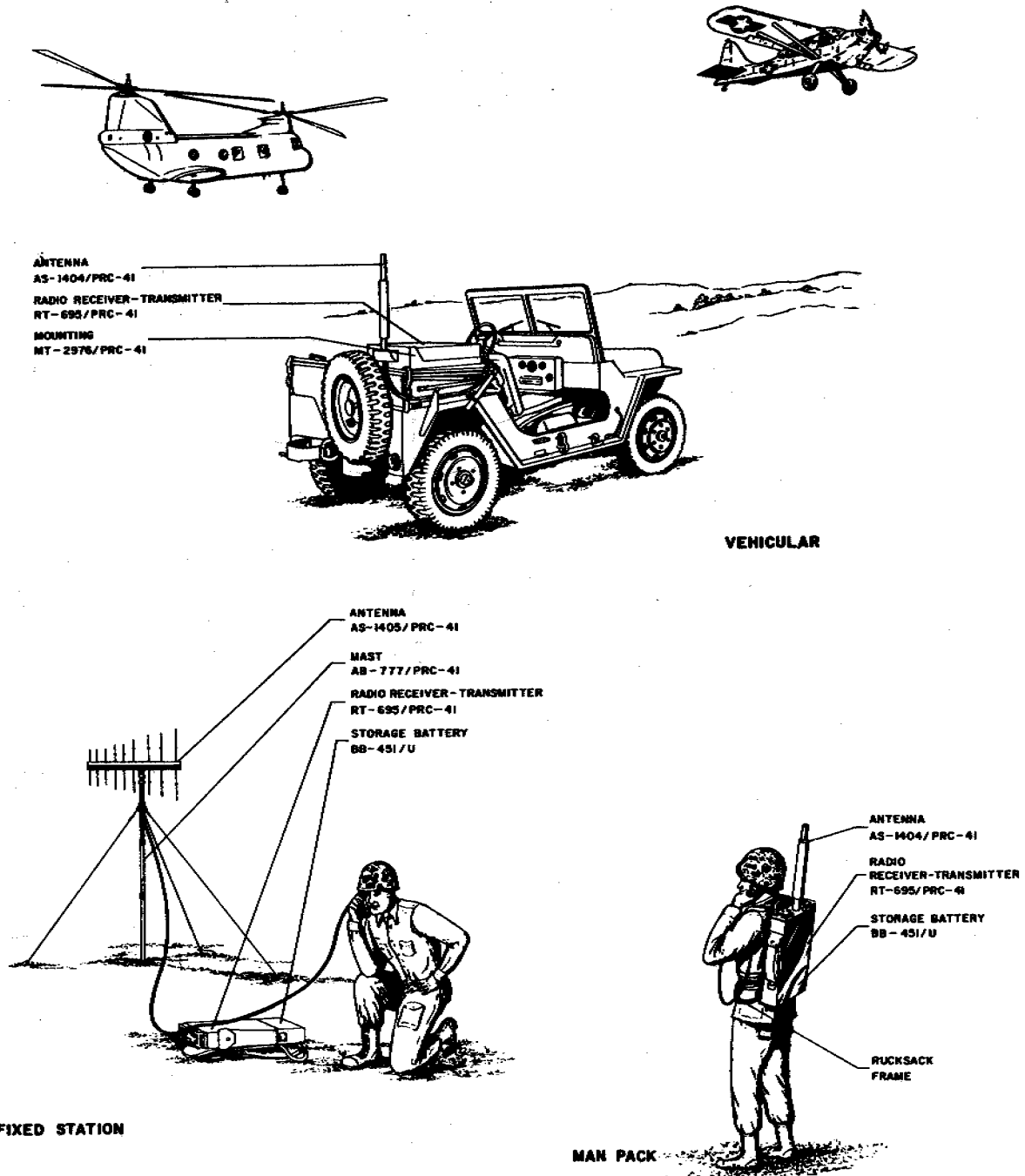

Figure 1-1. Radio Set AN/PRC-41, Operating Configurations

SECTION 1

GENERAL INFORMATION

1-1. SCOPE.

The format and content of these manuals is in accordance with the requirements of Military Specification MIL-M-15071E (SHIPS) and Contact NObsr 87474. This manual includes sections 1, 2, 3, 7, and 8. The TM 11-5820-510-35 includes sections 1, 4, 5, and 6. These manuals are applicable to the items and accessories of Radio Set AN/PRC-41. Section 1 contains a general description, provides reference data, lists the applicable items and accessories, and provides information required for the preparation for reshipment of the Radio Set AN/PRC-41 equipment. Section 2 provides installation information such as unpacking, power requirements for operation, site selection, inspection and adjustment, and interference reduction. Section 3 contains operating instructions. Section 4 provides a theoretical description and test data of the functional sections and subordinate circuits of the equipment. Section 5 provides preventive maintenance instructions, repair information, and illustrations which are applicable to all sections such as part location, exploded views, connection diagrams, and over-all equipment schematics. Section 6 lists the detail parts of the items and accessories of Radio Set AN/PRC-41. Section 7 is preventive maintenance. Section 8 covers troubleshooting. These technical manuals are in effect upon receipt. Extracts from this publication may be made to facilitate the preparation of other Department of Defense publications.

1-1.1. INDEX OF PUBLICATIONS

Refer to the latest issue of DA Pam 310-4 to determine whether there are new editions, changes, or additional publications pertaining to the equipment. Department of the Army Pamphlet No. 310-4 is an index of current technical manuals, technical bulletins, supply manuals (types 4, 6, 7, 8, and 9), supply bulletins, lubrication orders, and modification work orders that are available through publications supply channels. The index lists the individual parts (-10, -20, -35P, etc.) and the latest changes to and revisions of each equipment publication.

1-1.2. FORMS AND RECORDS

a. Reports of Maintenance and Unsatisfactory Equipment. Use equipment forms and records in accordance with instructions in TM 38-750

b. Report of Damaged or Improper Shipment. Fill out and forward DD Form 6 (Report of Damaged or Improper Shipment) as prescribed in AR 700-58 (Army), NAVSANDA Publication 378 (Navy), and AFR 71-4 (Air Force)

c. Reporting of Equipment Manual Improvements. The direct reporting, by the individual user, of errors, omissions, and recommendations for improving this equipment manual is authorized and encouraged. DA Form 2028 will be used for reporting these improvements. This form may be completed using pencil, pen, or typewriter. DA Form 2028 will be completed in triplicate and forwarded by the individual using the manual. The original and one copy will be forwarded direct to: Commanding Officer, U. S. Army Electronics Materiel Support Agency, ATTN: SELMS-MP, Fort Monmouth, New Jersey, 07703. One information copy will be furnished to the individual's immediate supervisor (officer, noncommissioned officer, supervisor' etc.).

1-2. EQUIPMENT SUPPLIED.

Radio Set AN/PRC-41 consists of the equipment contained in Radio Set Case CY-3883/PRC-41. Refer to table 1-1 and figure 1-2. Radio Set Accessory Kit MK-706/PRC-41 consists of the equipment contained in Electronic Equipment Case CY-3885/PRC-41. Refer to table 1-2 and figure 1-3. Refer also to figure 1-1.

TABLE 1-1. RADIO SET AN/PRC-41, EQUIPMENT SUPPLIED

ITEM	QTY	NOMENCLATURE		OVER-ALL			VOL WT (cu in.) (lb)	
				DIMENSIONS (in.)				
		NAME	DESIGNATION	H	W	D		
1	1	Radio Set Case (less contents)	CY-3883/PRC -41	15-1/2	35	26-1/2	14,376	79
2	1	Radio Receiver - Transmitter (without CY-3884/PRC-41)	RT-695/PRC-41	14	11-5/16	4-9/16	812	18.5
3	1	Receiver-Transmitter Case	CY-3884/PRC-41	12-5/8	11-3/16	4-15/32	635	3.6
4	3	Storage Battery	BB-451/U	7-11/16	11-9/16	4-9/64	402	16
5	1	Antenna	AS-1404/PRC-41	23-1/2	1-3/4 dia			0.7

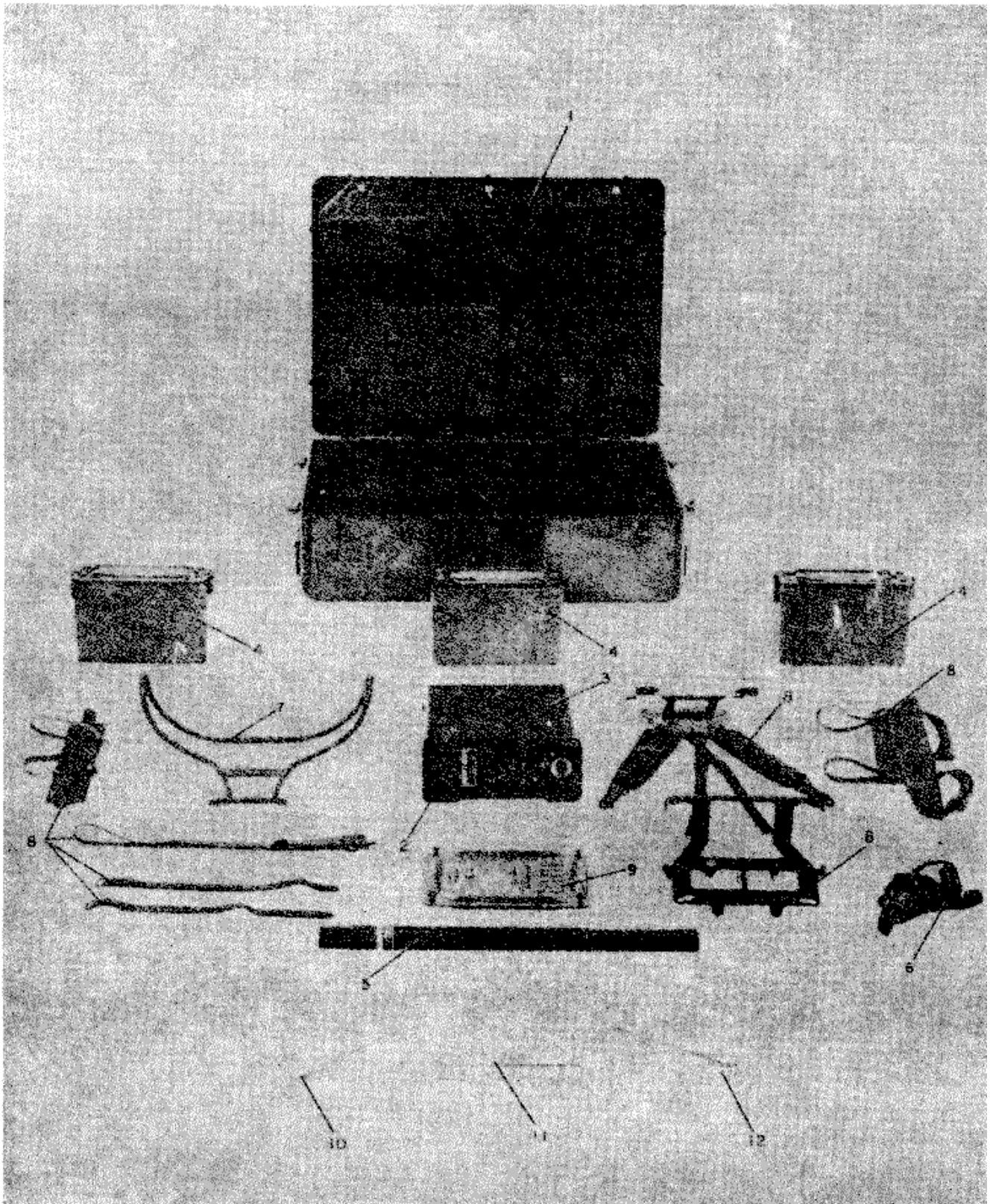

Figure 1-2. Radio Set AN/PRC-41, Equipment Contents of Radio Set Case CY-3883/PRC-41

ORIGINAL

TABLE 1-1. (Continued)

ITEM	QTY	NOMENCLATURE		OVER-ALL DIMENSIONS (in.)			VOL (cu in.)	WT (lb)
		NAME	DESIGNATION	H	W	D		
6	1	Handset	H-33E/PT (GFE)	2	8	3-3/8	1.2	
7	1	Rucksack Frame	(GFE)	19	17	6-1/4	1.5	
8	1	Harness Set	3.1					
9	1	Equipment Repair Parts and Bracket	8-1/2	11	1-5/8	1.0		
10	2	Operator and Organizational Manual	TM 11-5820-510-12	8-1/2	11	1-1/2		
11	2	Field and Depot Maintenance Manual Depot	TM 11-5820-510-35,	8-1/2	11	1-3/4		
12	1	Repair Parts List	8-1/2	11	11			

TABLE 1-2. RADIO SET ACCESSORY KIT MK-706/PRC-41, EQUIPMENT SUPPLIED

ITEM	QTY	NOMENCLATURE		OVER-ALL DIMENSIONS (in.)			VOL (cu in.)	WT (lb)
		NAME	DESIGNATION	H	W	D		
1	1	Electronic Equipment Case (less contents)	CY-3885/PRC-41	15-1/2	35	26-1/2	14,376	65
2	1	Power Supply	PP-3700/PRC-41	7-47/64	10-15/16	4-5/32	355	17.6
3	1	Antenna	AS-1405/PRC-41	3-1/2	30-27/32	27-11/16		6.3
4	1	Mast	AB-777/PRC-41	78-1/4 28-1/4	3-1/2 open, 3-1/2 closed			3.0
5	1	Adjustable Antenna Mast Adapter		10-3/4	1-7/8			1.0

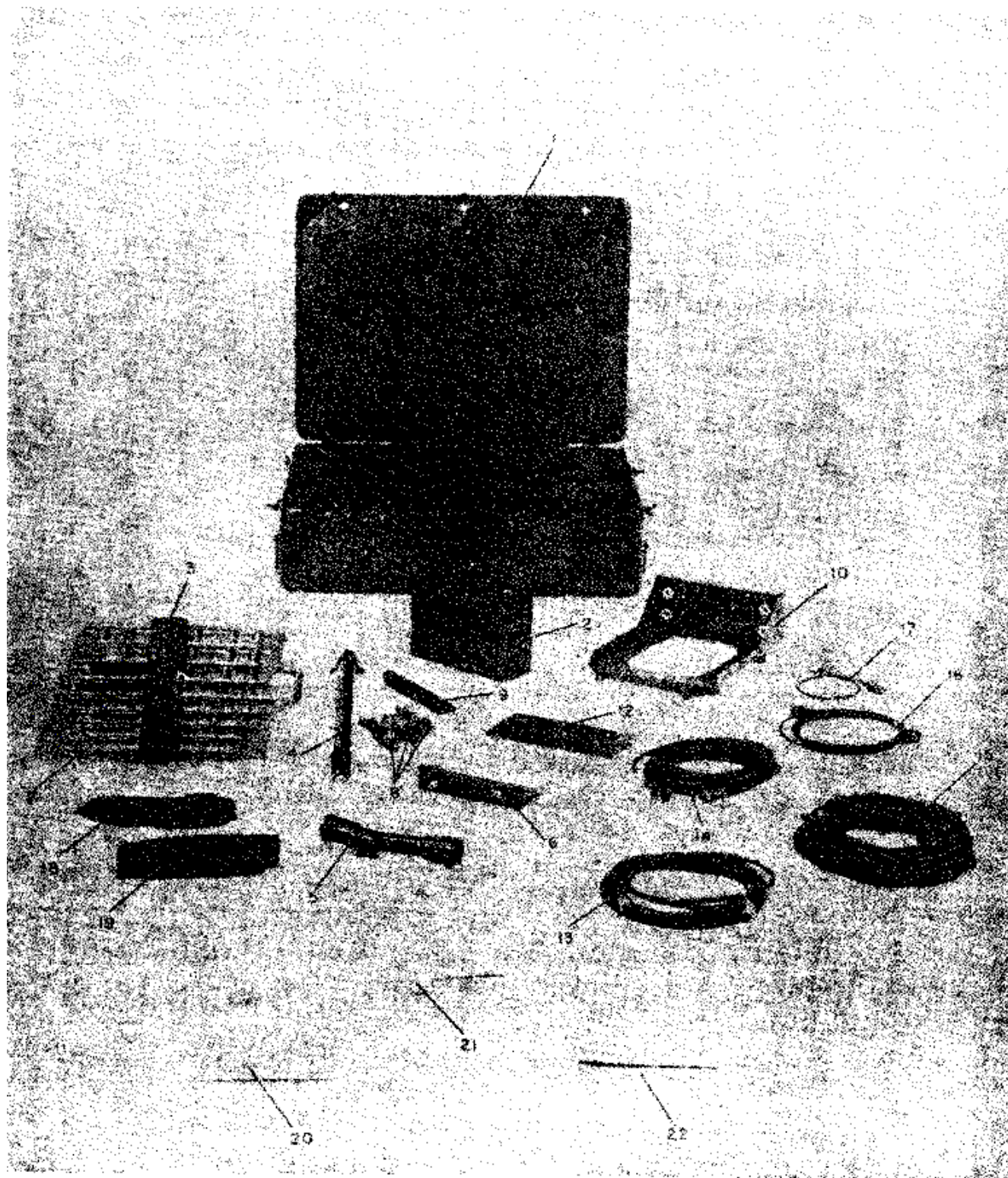

Figure 1-3. Radio Set Accessory Kit MK-706/PRC-41, Accessory Contents of Electronic
Equipment Case CY-3885, PRC-41

ORIGINAL

TABLE 1-2. (Continued)

ITEM	QTY	NOMENCLATURE		OVER-ALL DIMENSIONS (in.)			VOL (cu in.)	WT (lb)
		NAME	DESIGNATION	H	W	D		
21	2	Repair and Maintenance Technical Manual	TM-03816A-35/2	8-1/2	11	1-3/4		
22	1	Repair Parts List		8-1/2	11	1-3/4		4.8
8	3	Guy Rope Accessory		10 ft				1.5
9	3	Guy Stake		10	1	1		2.1
10	1	Bag (for Guy Stake)		12	5			0.1
11	1	Mounting	MT-2976/PRC-41	6-1/8	17-3/4	11-13/16	1230	6.6
12	1	Mounting	MT-2977/PRC-41	17/32	11-1/2	5-3/8	31	2.1
13	1	Radio Frequency Cable Assembly	CG-55G/U	20 ft				2.4
14	1	Power Electric Cable Assembly	CX-8686/PRC-41	20 ft				2.8
15	1	Power Electric Cable Assembly	CX-8687/PRC-41	50 ft				5.4
16	1	Special Purpose Electrical Cable Assembly	CX-8688/PRC-41	10 ft				1.0
17	1	D-C Adapter Cable		27				0.3
18	1	Maintenance Cable Kit		12	5			
19	1	Tool Kit		7-1/4	3-1/2			0.8
20	2	Installation and Operation Technical Manual	TM-03816A-12/1	8-1/2	11	1-3/4		

ORIGINAL

TABLE 1-2. (Continued)

ITEM	QTY	NOMENCLATURE		OVER-ALL DIMENSIONS (in.)			VOL (cu in.)	WT (lb)
		NAME	DESIGNATION	H	W	D		
21	2	Repair and Maintenance Technical Manual	TM-03816A-35/2	8-1/2	11	1-3/4		
22	1	Repair Parts List		8-1/2	11			
8	3	Guy Rope Accessory		10 ft				1.5

* Unless otherwise stated, all over-all dimensions are in inches.

1-3. EQUIPMENT REQUIRED BUT NOT SUPPLIED.

The equipment required for maintenance of the Radio Set AN/PRC-41 equipment is listed in table 1-3.

TABLE 1-3. EQUIPMENT REQUIRED BUT NOT SUPPLIED

QTY PER EQUIP.	NOMENCLATURE		REQUIRED USE	RADIO SET AN/PRC-41 EQUIPMENT CHARACTERISTICS
	NAME	DESIGNATION		
1	Signal Generator	AN/USM-44A or AN/URM-26B	Guard and main receiver functional section trouble-shooting and maintenance procedures	Frequency range: 225 to 400 mc. Type of signal: AM. Modulation: 1000 cps internal with external provisions.
1	Signal Generator	AN/URM-25D	Trouble-shooting and maintenance procedures.	Frequency range: 10 cps to 50 mc. Type of signal: AM. Output voltage: 0.1 to 100,000 microvolts.
1	R-F Wattmeter	AN/URM-43C or TS-1389	Power output measurements.	Power output: 0 to 5 watts. Impedance: 50 ohms.
1	Oscilloscope	AN/USM-105A	Trouble-shooting and maintenance procedures.	General purpose.
1	Output Power Meter or Output Meter	ME-2/U or ME-184 TS-585B/U	Audio output measurements.	Power output: 0 to 1 watt. Impedance: 300 ohms.
1	Audio Oscillator	TS-382B/U or AN/URM-127	Trouble-shooting and maintenance procedures.	Frequency: 100 to 10,000 cps. Output: 0 to 2 volts.

ORIGINAL

TABLE 1-3. (Continued)

QTY PER EQUIP.	NOMENCLATURE		REQUIRED USE	RADIO SET AN/PRC-41 EQUIPMENT CHARACTERISTICS
	NAME	DESIGNATION		
1	Fuse	MS-1730/U (p/o AN/USM-44)	Attenuator protection for signal generator.	R-f fuse: 225- to 400-mc range.
1	Multimeter	AN/PSM-4C	Trouble-shooting and maintenance procedures.	Voltage ranges: 0 to 250 volts dc. 0 to 250 volts ac. Ohmmeter section.
1	Electronic Multimeter	TS-505/U or AN/USM-116	Trouble-shooting and maintenance procedures.	Voltage ranges: 0 to 250 volts dc. 0 to 250 volts ac. Ohmmeter section.
1	Frequency Counter	AN/USM-122 or CAQI-524D	Frequency measurement.	Measurement frequencies in 20- to 30-mc and 225- to 400-mc ranges.
1	Electronic Frequency Converter	CV-394/USA-5 or CAQI-525C	Used with AN/USM-122 to extend the frequency measuring capabilities.	
1	Transfer Oscillator	CM-102/USM-73	Used with AN/USM-122 to extend the frequency measuring capabilities.	
1	Adjustable Attenuator	DA-233 or CAG-874-GA	An attenuator and T-connector used for modulation and signal measurements.	R-f attenuator to provide attenuation for high level outputs.
1	Signal Generator Pad	CN-315/URM-26 (p/o AN/URM-26B) or CBSH-50-6	Used for impedance matching between signal generator and radio equipment.	Pad attenuation: 6 db. Impedance: 50-ohm input and output. Frequency range: 225 to 400 mc.
1	Power Resistor		Used for loading Power Supply PP-3700/PRC-41 when performing tests.	Variable 0- to 20-ohm resistor, 100-watt.
1	Transistor Test Set	TS-110A/U	Used for checking transistors.	
1	Electron Tube Test Set	TV-7D/U	Used for checking electron tubes.	
1	Coaxial Crystal Detector	HP-420A (Hewlett-Packard)		R-f crystal for detection of modulated r-f signals.
1	Junction Box	To be fabricated. Refer to paragraph 5-2a(3).		

ORIGINAL

1-4. GENERAL DESCRIPTION.

Radio Set AN/PRC-41 is a lightweight, portable uhf receiver-transmitter equipment. The versatility of this equipment permits man-pack, fixed station, or vehicular operation. Refer to figure 1-1. The items and accessories of Radio Set AN/PRC-41 are listed in table 1-1. This equipment is stored for transit in Radio Set Case CY-3883/PRC-41 and Electronic Equipment Case CY-3885/PRC-41. Refer to figures 1-2 and 1-3. Radio Set Case CY-3883/PRC-41 contains the items necessary for man-pack operation. Electronic Equipment Case CY-3885/PRC-41 contains the accessory items required for fixed station or vehicular operation, and maintenance items such as tools and extender cables. Radio Receiver-Transmitter RT-695/PRC-41 of Radio Set AN/PRC-41 may be operated on any one of 1750 channels, spaced 100 kc in the 225.0- to 399.9-mc range. In transmit operation, the equipment uses type A3 (AM voice) emission and provides an average of 3 watts across the frequency range. All controls are an integral part of the front panel of Radio Receiver-Transmitter RT-695/PRC-41. These controls provide frequency selection, application of power, and adjustment of volume and squelch levels. Automatic relay operation may be provided when two Radio Receiver-Transmitter RT-695/PRC-41 equipments are operated together. Cabling is provided to permit remote operation. Primary power may be provided by either Storage Battery BB-451/U or Power Supply PP-3700/PRC-41. The equipment may use directional Antenna AS-1405/PRC-41 or omnidirectional Antenna AS-1404/PRC-41.

1-5. DESCRIPTION OF UNITS.

a. GENERAL. - Radio Set AN/PRC-41 is considered to include Radio Set Case CY-3883/PRC-41 and its contents. Refer to figure 1-2. Radio Set Accessory Kit MK-706/PRC-41 is considered to include Electronic Equipment Case CY-3885/PRC-41 and its contents. Refer to figure 1-3. The following paragraphs of this subsection provide physical, electrical, and functional descriptions of Radio Set Case CY-3883/PRC-41, Electronic Equipment Case CY-3885/PRC-41, and their contents.

b. RADIO SET AN/PRC-41.

(1) RADIO SET CASE CY-3883/PRC-41. Radio Set Case CY-3883/PRC-41 is a compartmentalized aluminum transit case used for storage of the items of Radio Set AN/PRC-41 which are required for man-pack operation. It measures 15-1/2 by 35 by 26-1/2 inches and weighs 45 pounds. Refer to figure 1-2.

(2) RADIO RECEIVER - TRANSMITTER RT-695/PRC-41. - Radio Receiver-Transmitter RT-695/PRC-41 consists of a main chassis with eight plug-in modules, a control panel, and a waterproof dust cover (Receiver-Transmitter Case CY-3884/PRC-41). Refer to figure 1-4. The modules are removable from the main chassis by loosening captive screws on each module. All electrical connections between the modules and the main chassis are made through multipin connectors on each module to jacks mounted on the main chassis. The coaxial

cables and the connectors, which are integral with the multipin connectors, conduct the r-f signals between the plug-in modules. Mechanical coupling for tuning functions is achieved by a mechanical gear train and couplers mounted on the main chassis, and the couplers of the mechanically tuned modules. The main chassis gear train is driven by the frequency selector controls on the front panel. Pressure contacts located at the rear of the main chassis provide the electrical connections for supplying the primary 26.5-volt d-c supply from either Storage Battery BB-451/U or Power Supply PP-3700/PRC-41. A coaxial connector located on the front panel mates with Antenna AS-1404/PRC-41 (omnidirectional) or with Radio Frequency Cable Assembly CG-55G/U when using Antenna AS-1405/PRC-41 (directional). The front panel also mounts a function switch for application of power, a volume control, a squelch control, three frequency selector controls, a window which indicates the frequency to which the component is tuned, and two Handset H-33E/PT audio output connectors.

(3) RECEIVER-TRANSMITTER CASE CY-3884/PRC-41. - Receiver-Transmitter Case CY-3884/PRC-41 is a dust cover for Radio Receiver-Transmitter RT-695/PRC-41. Refer to figure 1-4. The CY-3884/PRC-41 is secured to the RT-695/PRC-41 by four captive screws which are located at the rear of the CY-3884/PRC-41. With the CY-3884/PRC-41 in place on the RT-695/PRC-41, primary power is applied through pressure contacts located at the rear corners to the contacts centrally located on the inside rear of the CY-3884/PRC-41. The power is then available to the pressure contacts at the rear of the main chassis of the RT-695/PRC-41 and hence to the power distribution circuits of the RT-695/PRC-41.

(4) STORAGE BATTERY BB-451/U.

Refer to figure 1-5.

(a) GENERAL. - Storage Battery BB-451/U is a silver-zinc alkaline 24-volt (nominal) rechargeable storage battery. It is used to provide primary power to Radio Receiver-Transmitter RT-695/PRC-41 in a man-pack operation or where no other suitable power source is available. Three Storage Battery BB-451/U units are contained in Radio Set Case CY-3883/PRC-41.

(b) CONSTRUCTION. - The BB-451/U is contained in a watertight fiber glass case with a stainless steel cover plate. After removing the cover plate, the cells may be removed in groups of four using only ordinary hand tools. A plastic sheet for recording charging history is bonded to the underside of the cover plate. To avoid a long formation and activation period, the BB-451/U is supplied in a dry charge condition.

(c) CELLS. - The battery consists of 16 series-connected silver-zinc cells constructed in blocks of four cells each. Nominal open-circuit voltage of a fully charged cell is 1.86 volts per cell. The minimum voltage per cell under specified load is 1.375 volts at -11°C (+12°F) and above, and 1.250 volts from -10°C to -25°C (+14°F to -13°F).

ORIGINAL

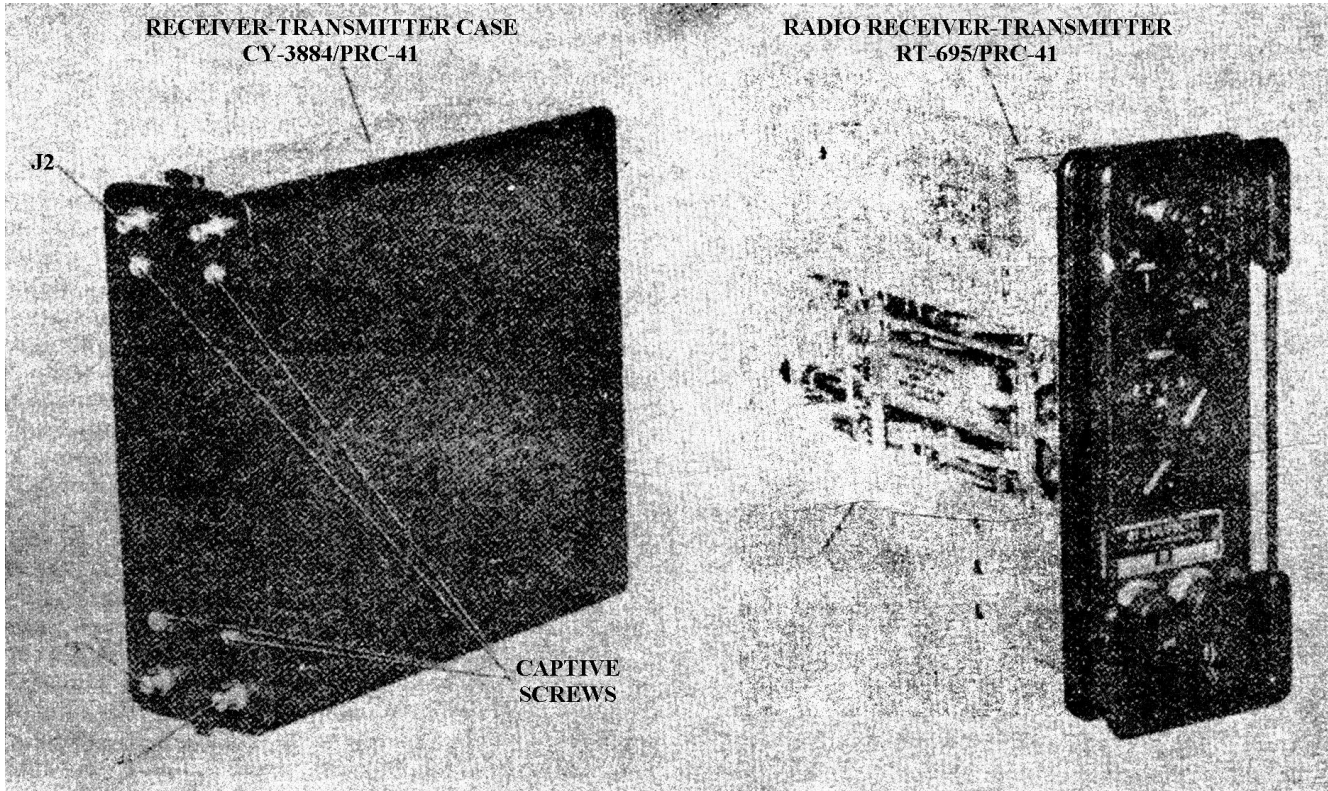

Figure 1-4. Radio Receiver-Transmitter RT-695/PRC-41
Receiver-Transmitter Case CY-3884/PRC-41 Displaced

(d) CHARGE RETENTION (DRY),

Charge retention of a dry, charged cell over the specified periods will be in accordance with the minimum values indicated below:

2 years at +30°C (+86°F) and below - 98% (19.6 ampere-hours)

1 year at +50°C (+122°F) and below - 80% (16 ampere-hours)

3 months at +65°C (+149°F) and below - 50% (10 ampere-hours)

(e) ACTIVATION. - The cells of the silver-zinc battery will deliver the specified ampere hour capacity after a 24-hour "soak" in the electrolyte, a 40-percent solution of potassium hydroxide and other additives furnished by the manufacturer. A booster charge is permissible if the temperature and storage limits of paragraph 1-5b(4)(d) above have been exceeded.

(f) CHARGE ACCEPTANCE. - The battery cells will perform according to specifications after charging at a modified constant current of 2.5 amperes average with voltage cutoff at 2.03 volts. Emergency charging of the cells is possible by charging at a constant potential of 2.03 volts per cell with charge acceptance as follows: a 0.5- charge period replaces 50 percent of the capacity .

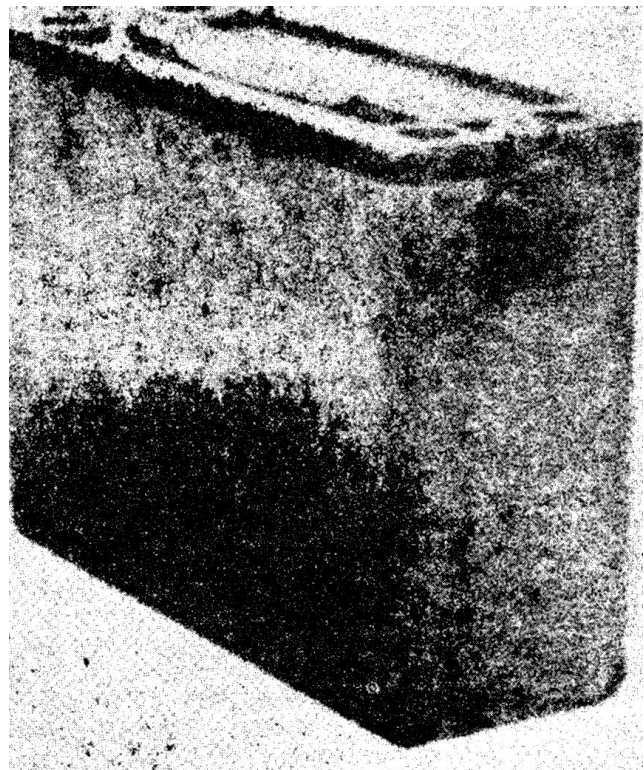

Figure 1-5. Storage Battery BB-451/U, Oblique View

removed on previous discharge; a 4-hour charge period replaces 60 percent of the capacity removed on the previous discharge. All recharging must be with Battery Charger PP-3240/U or its exact replacement.

(g) STORAGE. - Dry, charged cells are filled with an inert gas by the manufacturer and may be stored under the following conditions:

Temperature
range.... -65°C to +65°C (-85°F to +149°F)

Relative
humidity . . 100 percent

Attitude . . any

Altitude . . 40,000 ft

Wet, charged cells should be stored in an upright position.

For further detailed information concerning Storage Battery BB-451/U see TM-04072A-15/1.

(5) ANTENNA AS-1404/PRC-41. - Refer to figure 1-6. Antenna AS-1404/PRC-41 is an omnidirectional antenna for use with Radio Receiver- RT-695/PRC-41. The AS-1404/PRC-41 is used for transmission and reception of signals in the 225- to 399.9-mc range without electrical or physical adjustments. It may be mounted directly on antenna connector J28 on the front panel of Radio Receiver-Transmitter RT-695/PRC-41 or the connector on the antenna mounting bracket; or, when mounted on Mast AB-777/PRC-41, it must be connected through Adapter UG-29B/U and Radio Frequency Cable Assembly CG-55G/U to the RT-695/ PRC-41.

(6) HANDSET H-33E/PT. - Refer to figure 1-6. Handset H-33E/PT is made up of a headpiece, a length of cable, and a connector which mates with either AUDIO connector on the front panel of Radio Receiver-Transmitter RT-695/PRC-41. The H-33E/ PT contains a transmitter, a receiver, and a press-button. In operation, pressing the press-to button places the RT-695/PRC-41 equipment in transmit operation; releasing returns the equipment to receive operation.

(7) RUCKSACK FRAME. - Refer to figure 1-6. The rucksack frame is a government furnished equipment. The rucksack frame and associated straps and harness provide a back-pack frame for carriage of Radio Receiver-Transmitter RT-695/PRC-41, Storage Battery BB-451/U, and Antenna AS-1404/ PRC-41 in man-pack operation.

c. RADIO SET ACCESSORY KIT MK-706/PRC-41.

(1) ELECTRONIC EQUIPMENT CASE CY-3885/ PRC-41. - Electronic Equipment Case CY-3885/PRC-41 is a compartmentalized aluminum transit case used for storage of accessories of Radio Set AN/PRC-41. The contents of Electronic Equipment Case CY-3885/PRC-41 permit operation of the AN/PRC-41 equipment in a fixed station or vehicular configuration, and provide extender cables and tools required for

equipment maintenance. The case measures 15-1/2 by 35 by 26- 1/2 inches and weighs 45 pounds. Refer to figure 1-3.

(2) POWER SUPPLY PP-3700/PRC-41.. Refer to figure 1-7. The circuitry of Power Supply PP-3700/PRC-41 is contained in an aluminum case having the same dimensional configuration as Storage Battery BB-451/U. Power Supply PP-3700/PRC-41 is used to provide the 26.5-volt d-c primary power for Radio Receiver-Transmitter RT-695/PRC-41 where either 115- or 230-volt, 50- to 400-cps power is available. Refer to paragraph 2-5b(1). This component may be clamped directly to the rear of Radio Receiver-Transmitter RT-695/PRC-41 or its primary power may be made available by use of Power Electric Cable Assembly CX-8686/PRC-41 connected between the d-c connector on the side of the PP-3700/ PRC-41 and the rear of Mounting MT-2976/PRC-41. When operating the RT-695/PRC-41 on the test bench with Receiver-Transmitter Case CY-3884/ PRC-41 removed, primary power may be made available to the RT-695/PRC-41 by use of the d-c maintenance adapter. Power Supply PP-3700/PRC-41 may also be mounted on Mounting MT-2977/PRC-41.

(3) MOUNTINGS MT-2976/PRC-41 AND MT-2977/ PRC-41. - Refer to figure 1-8. Mounting MT-2976/PRC-41 is used to mount Radio Receiver- RT-695/PRC-41. This is normally used for a vehicular installation. Power Electric Cable Assembly CX-8686/PRC-41 may be connected to the input connector at the rear of the MT-2976/PRC-41. Mounting MT-2976/PRC-41 contains circuitry to prevent voltage polarity reversal from damaging the RT-695/PRC-41 and filter circuits for input filtering of the primary power voltage. Primary power is taken from the input connector at the rear of the MT-2976/ PRC-41, fed through the mounting circuitry, and made available to the connectors at the front of the rear bracket of the MT-2976/PRC-41. These connectors mate with those at the rear of Receiver-Transmitter Case CY-3884/PRC-41. Two take-up fasteners are located at the front of the MT-2976/PRC-41 which clamp over the protection handles on the front panel of the RT-695/PRC-41 and hold the contacts at the rear of the CY-3884/PRC-41 in contact with the contacts at the front of the rear bracket of the MT-2976/PRC-41. Mounting MT-2977/PRC-41 is used normally for fixed station installation for mounting Power Supply PF-3700/PRC-41.

(4) ANTENNA AS-1405/PRC-41 AND ACCESSORIES. - Refer to figure 1-9. Antenna AS-1405/PRC-41 is a directional antenna for use with Radio Receiver - Transmitter RT-695/PRC-41. The AS-1405/PRC-41 is used for transmission and reception of signals in the 225- to 399.9-mc range. The elements of Antenna AS-1405/PRC-41 are made collapsible for storage. The AS-1405/PRC-41 is a planer log periodic dipole array which provides unidirectional directivity characteristics. Antenna AS-1405/PRC-41 mounts on an adjustable antenna mast adapter and Mast AB-777/PRC-41. Guy ropes and stakes permit Mast AB-777/PRC-41 to be staked in place in a fixed station installation. The adjustable antenna mast adapter permits

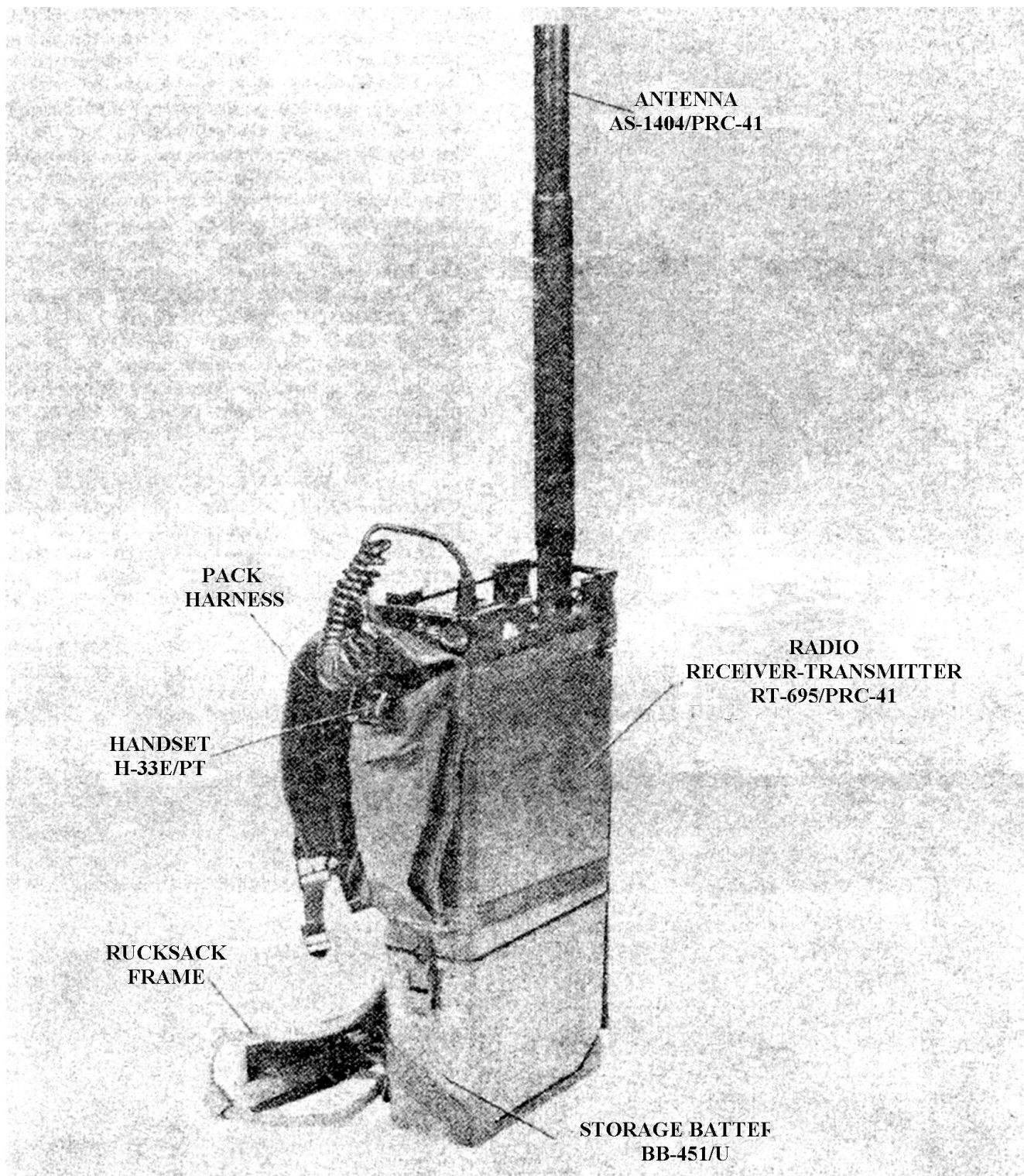

Figure 1-6. Radio Set AN/PRC-41. Man-Pack Operation Configuration

ORIGINAL

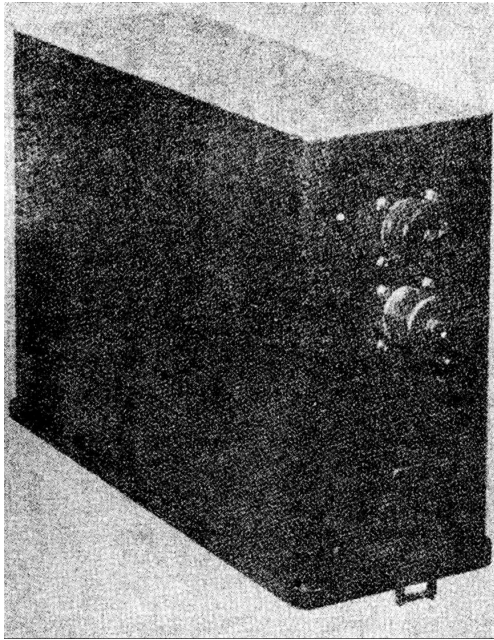

Figure 1-7. Power Supply PP-3700/PRC-41, Oblique View

elevation orientation of Antenna AS-1405/PRC-41. Radio Frequency Cable Assembly CG-55G/U connects between Antenna

AS-1405/PRC-41 and the antenna connector on the front panel of Radio Receiver-Transmitter RT-695/PRC-41. The AS-1405/PRC-41 may be stored in the directional antenna carrying bracket

(5) ANTENNA MOUNTING BRACKET. Refer to figure 1-10. The antenna mounting bracket permits vertical mounting of omnidirectional Antenna AS- 1404/PRC-41 in a vehicular installation. It is normally mounted on the rear of Mounting MT-2976/PRC-41 but may be secured to any flat vertical surface by four screws or bolts. The antenna mounting bracket has a BNC-to-BNC feedthrough connector. The upper part of this connector fits Antenna AS-1404/PRC-41 and the lower part mates with a connector on Radio Frequency Cable Assembly CG- 55G/U.

(6) RADIO FREQUENCY CABLE ASSEMBLY CG-55G/U. - Refer to figure 1-11. Radio Frequency Cable Assembly CG-55G/U is a 20-foot length of RG-213/U coaxial cable with mating connectors. It is used for connection between the antenna connector on the front panel of Radio Receiver- RT-695/PRC-41 and Antenna AS-1405/ PRC -41.

(7) POWER ELECTRIC CABLE ASSEMBLY CX-8686/PRC-41. - Refer to figure 1-11. Power Electric Cable Assembly CX-8686/PRC-41 is a 20-foot length of three-wire electrical cable with mating connectors. It is used for connection of Power Supply PP-3700/FRC-41 to Mounting MT-2976/PRC-41.

(8) POWER ELECTRIC CABLE ASSEMBLY CX-8687/PRC-41. - Refer to figure 1-11. Power Electric Cable Assembly CX-8687/PRC-41 is a 50- length of three-wire cable

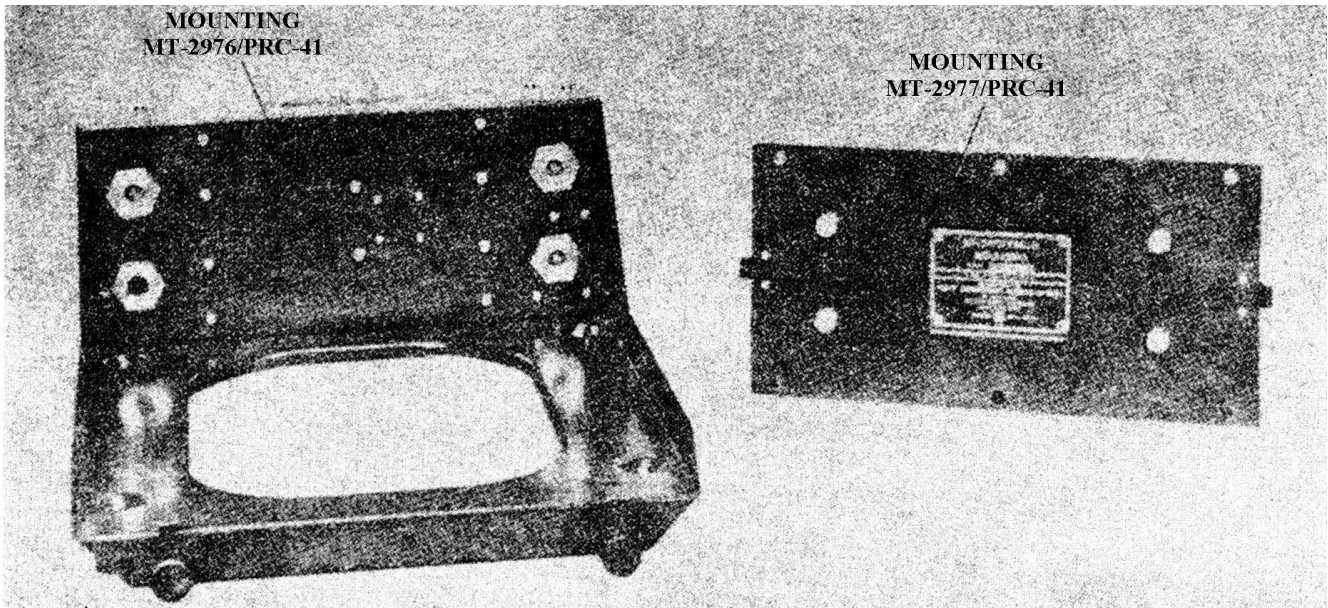

Figure 1-8. Mounting MT-2976/PRC-41 and MT-2977/PRC-41, Oblique Views

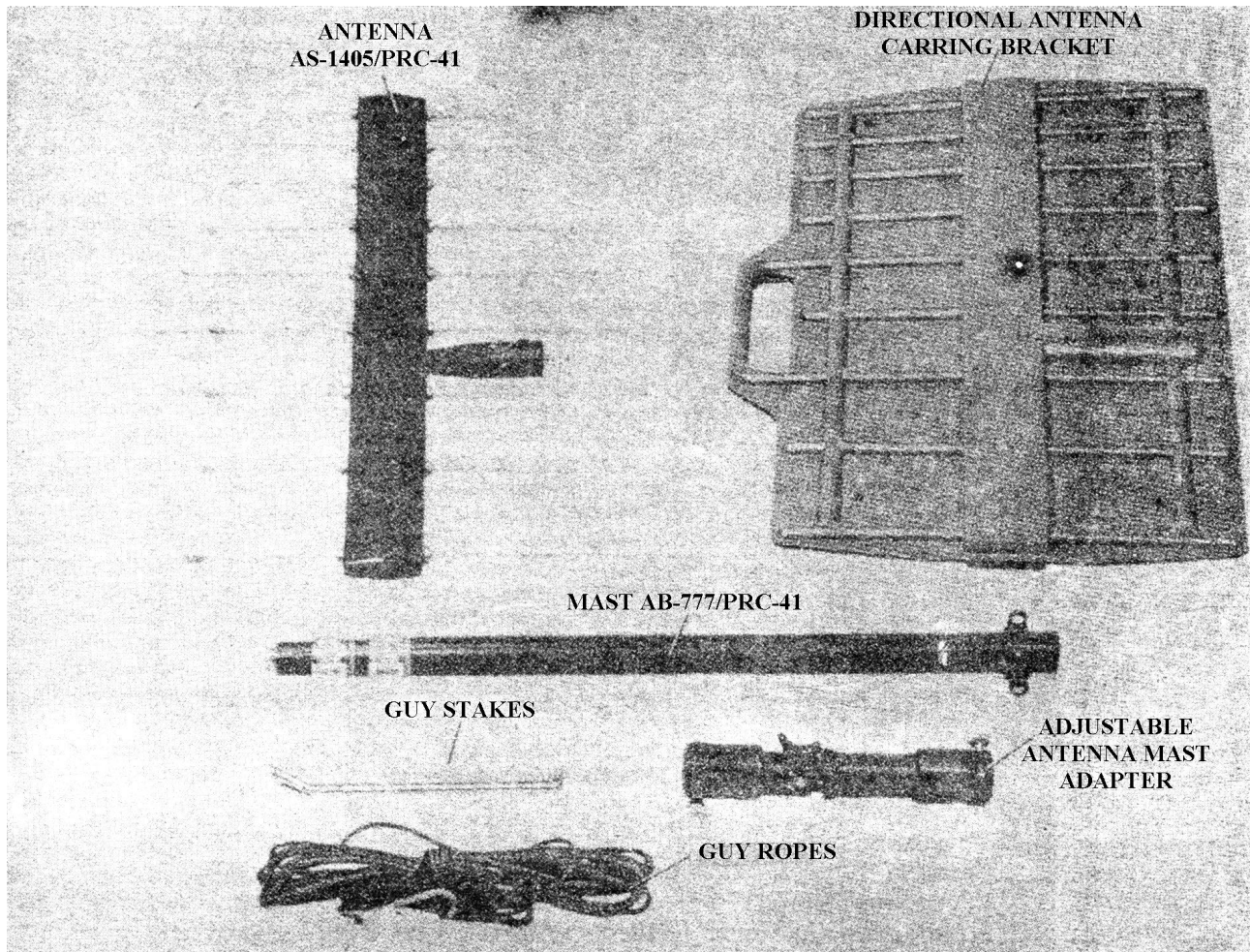

Figure 1-9. Antenna AS-1405/PRC-41, Mast AB-777/PRC-41, and Accessories

with suitable mating connectors. It is used to connect Power Supply PP-3700/PRC-41 to a 115-volt, 50- to 400-cps primary supply.

(9) SPECIAL PURPOSE ELECTRICAL CABLE ASSEMBLY CX-8688/PRC-41. - Refer to fig. 1-11. Special purpose Electrical Cable Assembly CX-8688/PRC-41 is a 10-foot length of seven- cable having suitable mating connectors. It is used to connect one of the AUDIO connectors on one Radio Receiver-Transmitter RT-695/PRC-41 to one of the AUDIO connectors on another RT-695/ PRC-41 for automatic relay operation. Refer to paragraph 2-4d.

(10) D-C ADAPTER CABLE. - Refer to fig. 1-11. The d-c adapter cable is a two-wire cable used in a vehicular installation to connect power between the vehicle d-c power source and the rear connector of Mounting MT-2976/PRC-41 through Power Electric Cable Assembly CX-8688/PRC-41.

(11) MAINTENANCE CABLE KIT. - Refer to figure 1-12. The maintenance cable kit is composed of five

multipin cables, two Conhex cables, a BNC-to-Conhex connector, a Conhex-to-Conhex connector, and a d-c maintenance adapter. The multi- and Conhex cables are used for operating the modules of Radio Receiver-Transmitter RT-695/PRC-41 extended from the main chassis while performing maintenance procedures. The BNC-to- and Conhex-to-Conhex connectors provide adaptations for connection of test equipment. With Receiver-Transmitter Case CY-3884/PRC-41 removed from Radio Receiver-Transmitter RT-695/ PRC-41, the d-c maintenance adapter may be secured to the rear of the RT-695/PRC-41. This permits application of primary power while performing maintenance procedures. The d-c maintenance adapter is a three-wire pressure contact to connector adapter. Refer to table 1-4.

(12) TOOL KIT. - Refer to figure 1-13. The tool kit contains the special tools supplied for adjustment and maintenance of Radio Receiver-Transmitter RT-695/PRC-41. Refer to table 1-5.

ORIGINAL

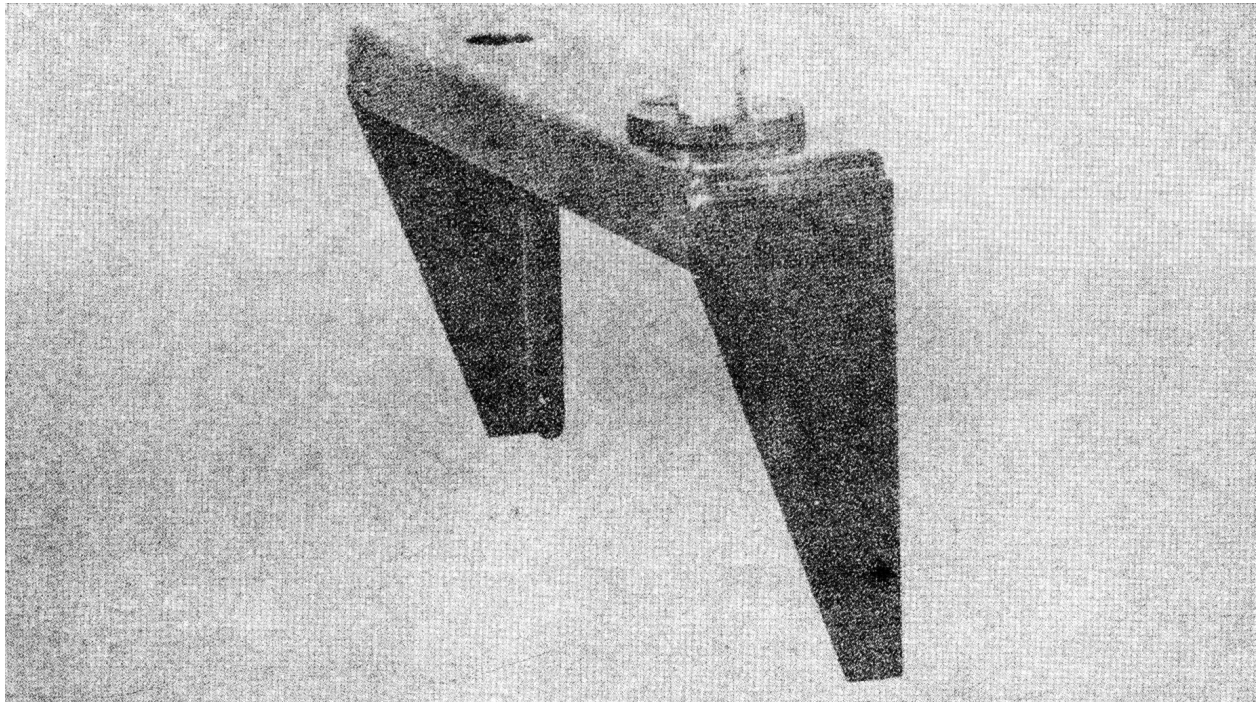

Figure 1-10. Antenna Mounting Bracket

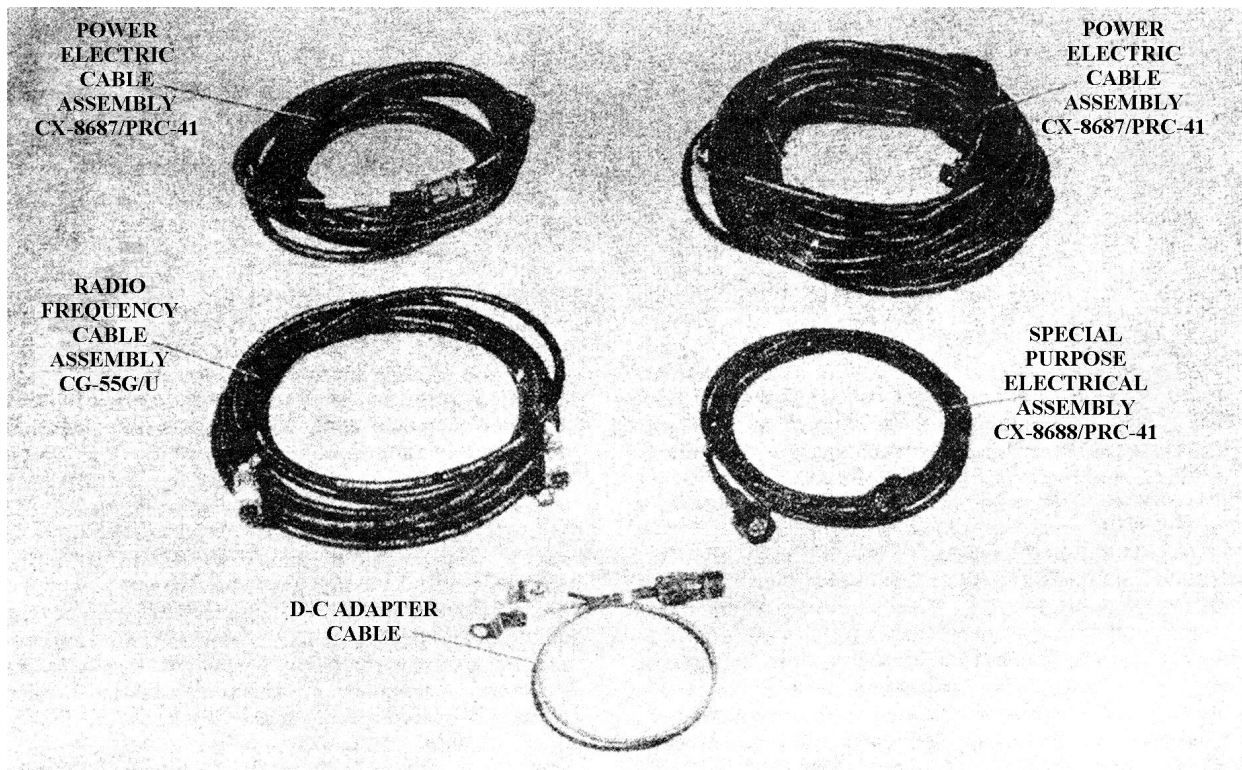

Figure 1-11. Cable Assemblies

TABLE 1-4. CONTENTS OF MAINTENANCE CABLE KIT

ITEM NUMBER	DESCRIPTION AND PURPOSE
1	Canvas bag, container for cables and adapters.
2	Extension cable W2 is an 18-inch cable terminated in Cannon DBM-P13C3P(C27)and Cannon DBMF-K13C3S(C27)-1, having 10 pins and three coaxial connections .Extension cable W2 is used with 1st and 2nd i-f amplifier module.
3	Extension cable W3 is an 18-inch cable terminated in Cannon DAM-H11C1P(C27)and Cannon DAMF-K11C1S(C27)-1, having 10 pins and one coaxial connection. Extension cable W3 is used with spectrum generator and guard receiver modules.
4	Extension cable W1 is an 18-inch cable terminated in Cannon DBM-A17C2P(C27)and Cannon DBM-53513-15, having 15 pins and two coaxial connections. Extension cable W1 is used with r-f and power amplifier module.
5	Extension cable W4 is an 18-inch cable terminated in Cannon DA-15P-C7 and Cannon DAF-15S-C7 connectors, having 15 pins. Extension cable W4 is used with 3rd i-f and squelch module.
6	Extension cable W5 is an 18-inch cable terminated in Cannon DE-9P and Cannon DEF-9S, having 9 pins. Extension cable W5 is used with d-c power supply, modulator, and audio modules.
7	Adapter At is a BNC-to-Conhex adapter required for connection of test equipment to equipment.
8	Adapter A2 is a Conhex-to-Conhex adapter required for connection of Conhex cables to extend their length.
9	Extension cable W7 is an 8-inch Conhex cable terminated in one Conhex 33-01 connector.
10	Extension cable W6 is an B-inch Conhex cable terminated in two Conhex 33-01 connectors.
11	Extension cable W8 is an 18-inch coaxial cable terminated in one Microdot 51-258 connector and one Microdot 3242 connector.
12	D-c maintenance adapter A3 is used to provide power to RT-695/PRC-41 when operated with CY-3884/PRC-41 removed. Adapter A3 secures to rear of RT-695/ PRC-41 by use of two captive screws. Electrically, d-c maintenance adapter has three pressure contacts like those in rear of CY-3884/PRC-41. These make contact with three pressure contacts on rear of RT-695/PRC-41 and are connected to three-pin plug on opposite side of d-c maintenance adapter bracket. This plug mates with CX-8686/PRC-41.
13	Adapter UG-29B/U permits connection of Radio Frequency Cable Assembly CG-55G/U to Antenna AS-1404/PRC-41 when used with mast AB-777/PRC-41.

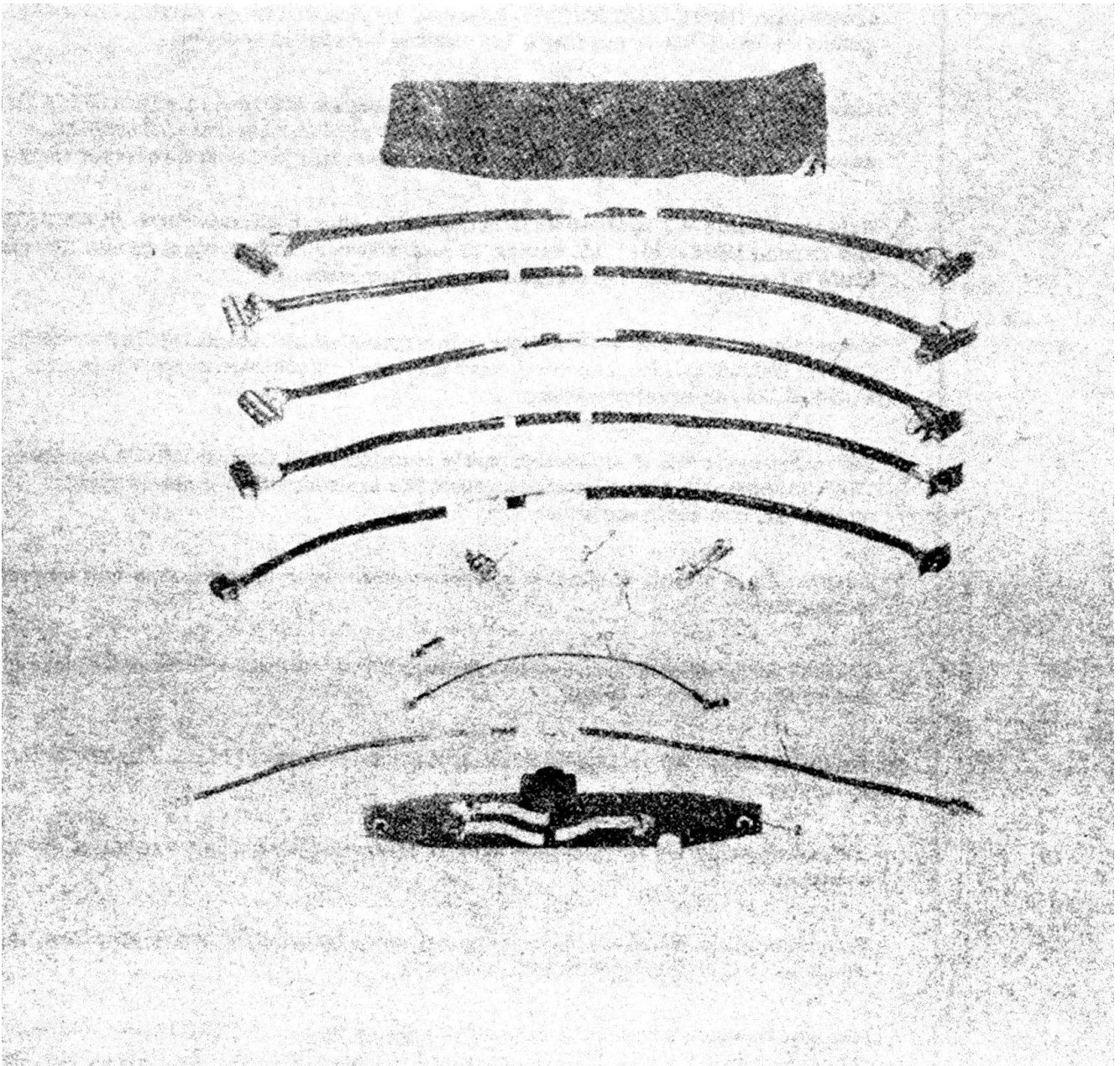

Figure 1-12. Maintenance Cable Kit

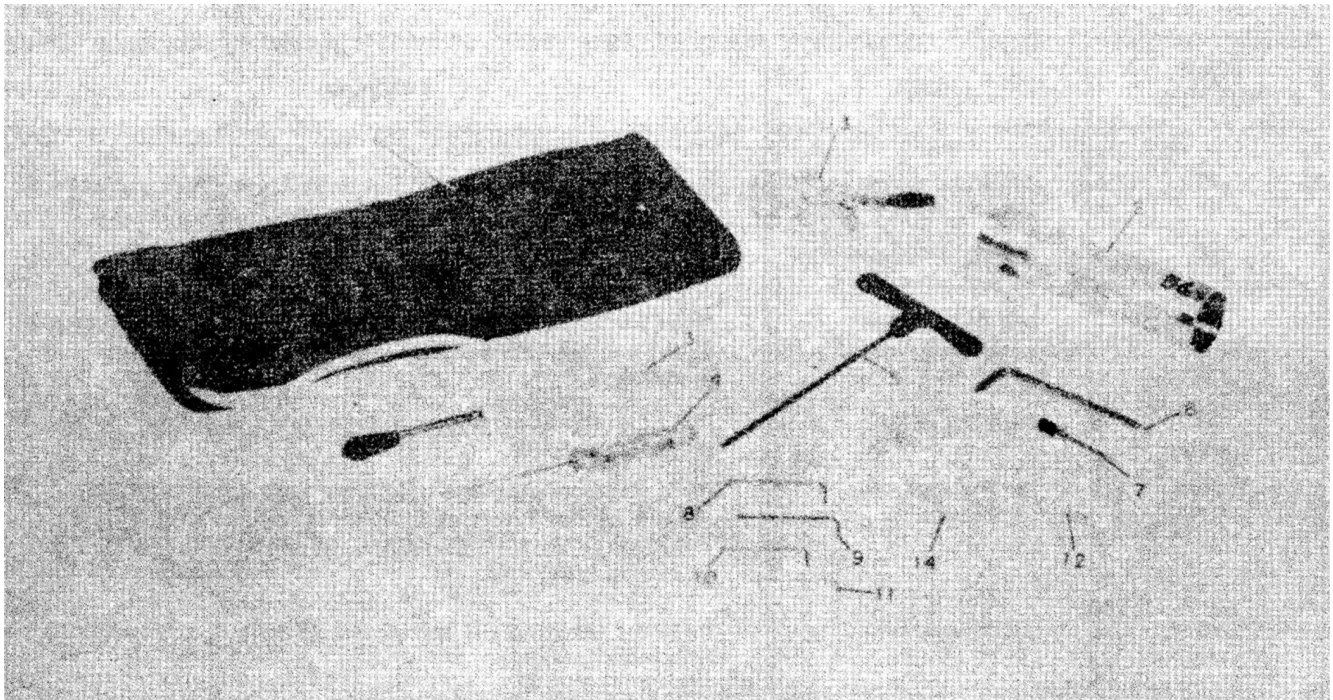

Figure 1-13. Tool Kit

TABLE 1-5. CONTENTS OF TOOL KIT

ITEM NUMBER	NAME	PURPOSE
1	Canvas bag	Container for tools.
2	Spanner wrench	Used for removing antenna connector J28 and AUDIO connectors on front panel of Radio Receiver-Transmitter RT-695/PRC-41, and antenna connector on antenna mounting bracket.
3	Brush	Used to clean connectors..
4	Screwdriver	Used for adjustment of trimpots and tuning capacitor of 1st and 2nd i-f amplifier, 3rd i-f and squelch, guard receiver, spectrum generator, modulator, and audio modules.
5	T-handle wrench	Used for loosening redheaded captive screws on modules of Radio Receiver-Transmitter RT-695/PRC-41.
6	Cross-recessed screwdriver	Used for removal and replacement of module side cover screws and for removal of main chassis back plate of Radio Receiver-Transmitter RT-695/PRC-41.
7	Screwdriver	Used for adjustment of capacitor 1A2C30 of 1st and 2nd i-f amplifier mo dule.
8	Multiple spline socket wrench #8	Used to tighten all coupler clamps on main chassis gear train.

TABLE 1-5. (Continued)

ITEM NUMBER	NAME	PURPOSE
9	Multiple spline socket wrench #6	Used for setscrews on all knobs on front panel and set screws in gears of main chassis of RT-695/PRC-41.
10	Multiple spline socket wrench #4	Used for setscrews in main chassis gear train, as required
11	Multiple spline socket wrench #2	Used for adjustment of rotor and grounding hub setscrews in r-f and power amplifier, and spectrum generator modules.
12	Alignment tool	Used for adjusting trimmer capacitors of r-f and power amplifier module.
13	Screwdriver	Used for loosening and tightening redheaded captive screws of dust cover of Power Supply PP-3700/PRC-41 and Storage Battery BB-451/U, and Receiver-Transmitter Case CY-3884/PRC-41.
14	Alignment tool	Used for tracking r-f and power amplifier, and spectrum generator modules.

1-6. REFERENCE DATA.

a. POWER REQUIREMENTS. - 26.5 volts dc+10 percent (equipment will operate with an input voltage as low as 22 volts dc) or 115 or 230 volts ±10 percent, 50-to-400-cps single phase. Equipment is normally connected for 115 volts; cable fabrication is required for operation from a 230-volt source. Refer to section 2 of Installation and Operation Technical Manual for Radio Set AN/PRC-41.

b. FREQUENCY DATA.

- (1) Range: 225.0 to 399.9 mc.
- (2) Channels: 1750 spaced at 100-kc intervals over the range.
- (3) Stability: ±15 kc.
- (4) Type of frequency control: Crystal.
- (5) Number of crystals: 39 crystals.
- (6) Type of transmission and reception: A3.

c TRANSMITTER DATA.

- (1) Power output: 3 watts average unmodulated power into a 50-ohm load.
- (2) Modulation: AM.
- (3) Modulation sensitivity: Carbon microphone input of 1.0 volt.
- (4) Modulation capability: 80 percent minimum (adjusted to clip between 70 to 90 percent).
- (5) Transmitter fidelity: +1, -3 db, 300 to 3500 cps (from 1000-cps reference).
- (6) Transmitter distortion: Less than 10 percent with modulation 3 db below clipping level.
- (7) Duty cycle: 1-minute transmit, 9-minute receive.

d RECEIVER DATA.

- (1) Sensitivity: A signal having an average level of 3 uv modulated 30 percent at 1000 cps produces 7 mw at a signal-plus-noise to noise ratio of 10 db or greater.
- (2) Selectivity: 6 db, 47 kc minimum; 60 db, 120 kc maximum.
- (3) Images and spurious responses: 70 db
- (4) I-f rejection: 80 db down.
- (5) Avc characteristics: Output within ±3 db from 10 to 100,000 uv (from 1000-microvolt reference).
- (6) Blocking: No blocking for input signals up to, 0.5 volt.
- (7) Squelch operation: A change in audio output of at least 10 db is effected by a 1-db change in input signal.
- (8) Ultimate S+N/N ratio: At least 35 db (measured at 1000 uv).
- (9) Audio output: 50 mw into a 300-ohm load with 30-percent modulation, 1000 uv.
- (10) Audio fidelity: +1, -3 db from 300 to 3500 cps (from 1000-cps reference).
- (11) Audio distortion: Less than 10 percent at 50-mw output.

e. GUARD RECEIVER DATA.

- (1) Sensitivity: A signal having an average level of 5 uv into the guard receiver modulated 30 percent at 1000 cps produces 7 mw at a signal plus-noise to noise ratio of 10 db or greater.
- (2) Selectivity: 6 db, 50 kc minimum; 60 db, 200 kc maximum.
- (3) Images and spurious responses: 60 db down.
- (4) I-f rejection: 80 db down.
- (5) Avc characteristics: Output within ±3 db from 10 to 100,000 uv (from 1000-microvolt reference).

(6) Blocking: No blocking for input signals up to 0.5 volt.

(7) Squelch operation: A change in audio output of at least 10 db is effected by a 1-db change in input signal.

(8) Ultimate S+N/N ratio: At least 35 db (measured at 1000 uv).

(9) Audio output: 50 mw into a 300-ohm load with 30-percent modulation, 1000 uv.

(10) Audio fidelity: +1, -3 db from 300 to 3500 cps (from 1000-cps reference).

(11) Audio distortion: Less than 10 percent at 50-mw output (1000-microvolt input, 1000 cps, 30-percent modulated).

1-7. FACTORY OR FIELD CHANGES.

Effective the date of this technical manual, there have been no factory or field changes of Radio Set AN/PRC-41 or Radio Accessory Kit MK-706/PRC-41.

1-8. PREPARATION FOR RESHIPMENT.

To prepare Radio Set AN/PRC-41 and Radio Set Accessory Kit MK-706/ C-41 for reshipment, return all items and accessories to their respective cases. Refer to figures 2-1 and 2-2. Replace Radio Set Case CY-3883/PRC-41 and Electronic Equipment Case CY-3885/PRC-41 in their packing boxes and carefully nail the crate planking in place. Properly mark the packing boxes for reshipment or storage.

SECTION 2
INSTALLATION

2-1. UNPACKING AND HANDLING.

The units and accessories of Radio Set AN/PRC-41 and Radio Set Accessory Kit MK-706/PRC-41 are contained in Radio Set Case CY-3883/PRC-41 and Electronic Equipment Case CY-3885/PRC-41 respectively. Radio Set Case CY-3883/PRC-41 contains the units and accessories required for man-pack operation. Electronic Equipment Case CY-3885/PRC-41 contains the units and accessories required for fixed station or vehicular operation, or for the performance of maintenance procedures. The location of the various units and accessories within these cases is illustrated in figures 2-1 and 2-2.

CAUTION

Extreme care should be exercised in uncrating Radio Set Case CY-3883/PRC-41 and Electronic Equipment Case CY-3885/PRC-41 to prevent scratching or other damage. Always use a nail puller rather than a hammer; do not attempt to pry the case open with a crowbar.

Open Radio Set Case CY-3883/PRC-41 and Electronic Equipment Case CY-3885/PRC-41, and check the units and accessories received against the packing slip and the list of equipment supplied. Refer to tables 1-1 and 1-2. Inspect each unit and accessory in each of the cases for evidence of damage. Report any damage or shortages to the transportation agency concerned.

2-2. POWER PROVISIONS AND DISTRIBUTION.

a. POWER PROVISIONS. - Radio Receiver- RT-695/PRC-41 requires a nominal 26.5-volt d-c primary source. This supply may be provided by use of Power Supply PP-3700/PRC-41, Storage Battery BB-451/U, or by an aircraft or vehicular battery supply. Figure 2-3 illustrates the various configurations which may be used to supply the required d-c primary power to Radio Receiver- RT-695/PRC-41.

Primary Power for Radio Receiver-Transmitter RT-695/PRC-41 may be provided by a separately located power supply PP-3700/PRC-41. Refer to part A of figure 2-3. In this configuration, Power Electric Cable Assembly CX-8686/PRC-41 is used to connect the 26.5-volt d-c output from the PP-3700/PRC-41 to Mounting MT-2976/PRC-41 and to the RT-695/PRC-41, Power Electric Cable Assembly CX-8687/PRC-41 is used to connect the 115-volt a-c primary power to Power Supply by PP-3700/PRC-41. Primary power for Radio

Receiver-Transmitter RT-695/PRC-41 may also be provided by Power Supply PP-3700/PRC-41 attached directly to the RT-695/PRC-41 as shown in part B of figure 2-3. This configuration uses Power Electric Cable Assembly CX-8687/PRC-41 to connect the primary 115-volt a-c supply to Power Supply PP-3700/PRC-41. For aircraft or vehicular operation, Radio Receiver- RT-695/PRC-41 may be mounted on Mounting MT-2976/PRC-41 and connected to the aircraft or vehicular battery supply through Power Electric Cable Assembly CX-8686/PRC-41 and the d-c adapter cable. Refer to part C of figure 2-3. For man-pack operation, Storage Battery BB-451/U is attached directly to the rear of Radio Receiver RT-695/PRC-41 to provide the required d-c primary supply voltage. Refer to part D of figure 2-3. For operation of Radio Receiver- RT-695/PRC-41 with its case removed, the d-c maintenance adapter must be secured to the rear of the RT-695/PRC-41 and Power Electric Cable Assembly CX-8686/PRC-41 must be connected between the d-c maintenance adapter and Power Supply PP-3700/PRC-41. The 115-volt a-c primary supply is then connected through Power Electric Cable Assembly CX-8687/PRC-41 to Power Supply PP-3700/PRC-41. Refer to part E of figure 2-3.

b. POWER DISTRIBUTION. - The primary power for Radio Receiver-Transmitter RT-695/PRC-41 is 26.5 volts dc. Power distribution to the modules and circuits of the RT-695/PRC-41 is illustrated schematically in figure 4-7 and described following paragraph 4-6d of the Repair and Maintenance Technical Manual for Radio Set AN/PRC-41. TM-03816A-35/2

2-3. SITE SELECTION.

Because Radio Set AN/PRC-41 is a uhf equipment, transmission and reception is considered to be line of sight. Maximum performance is thus obtained by line of sight operation.

2-4. INSTALLATION REQUIREMENTS.

The assembly layout of Radio Set AN/PRC-41 is dependent on the type of installation required. Radio Set AN/PRC-41 may be assembled for man- fixed station, or vehicular operation. Refer to figures 2-4 through 2-7. For outline and mounting dimensions, refer to figures 2-13 through 2-17.

a. MAN-PACK INSTALLATION. - Refer to figure 2-4. In man-pack installation, Radio Receiver- RT-695/PRC-41 is provided primary power by Storage Battery BB-451/U, and Antenna AS-1404/PRC-41 is connected directly

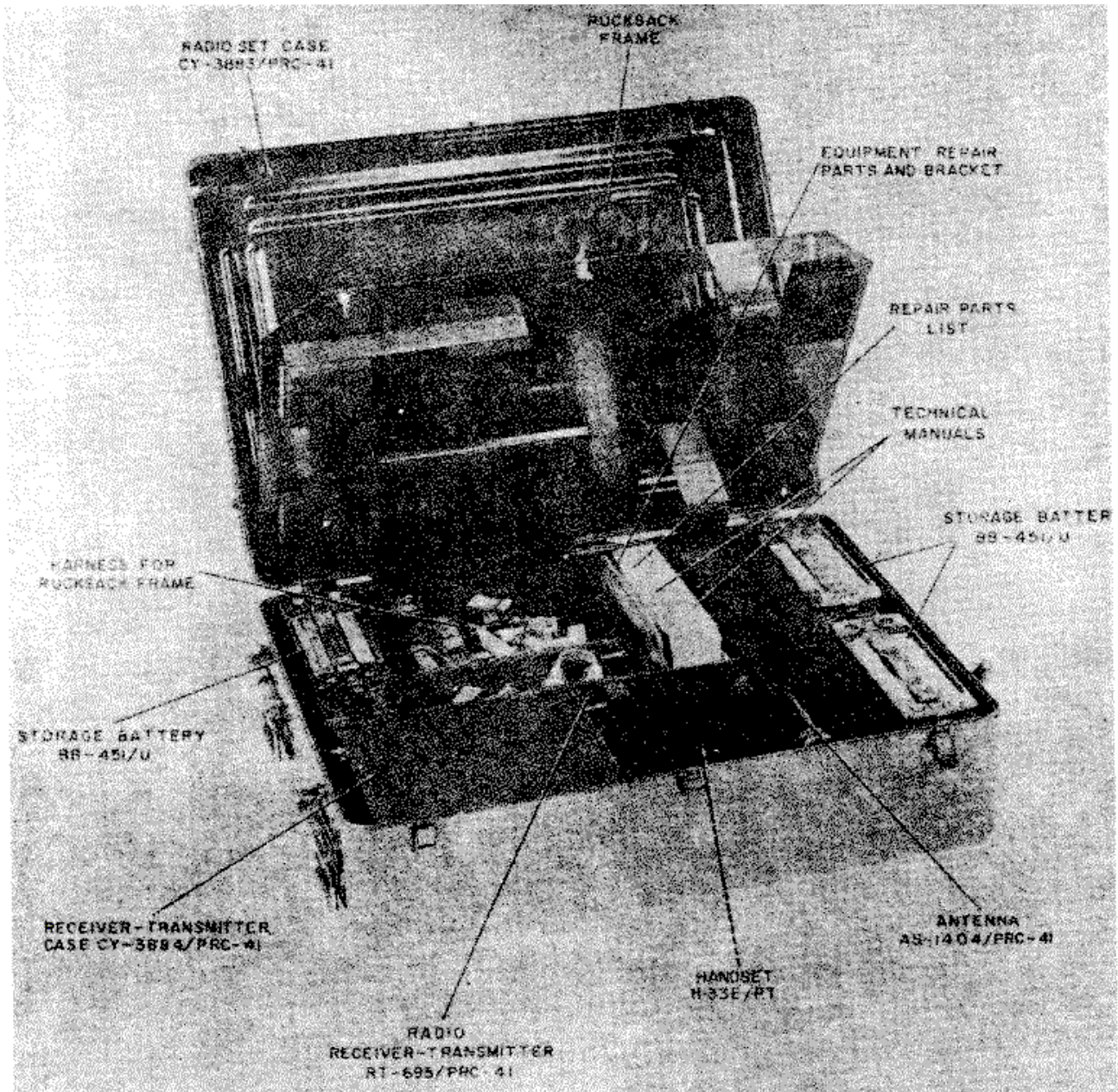

Figure 2-1. Location of Items of Radio Set AN/PRC-41 in Radio Set Case CY-3883/PRC-41

to antenna plug P8 on the front panel of Radio Receiver- RT-695/PRC-41. Connect Handset H-33E/PT to either of the front panel RT-695/PRC-41 AUDIO connectors. This equipment is then stowed on the rucksack frame. Storage Battery BB-451/U is supplied in a dry charge condition to avoid a long formation and activation period. For detailed information concerning BB-451/U see TM-04072A-15/1.

(1) STOWING EQUIPMENT FOR MANPACK- CP

ERATION. - Refer to figure 2-5. The strapping and harnessing required for man-pack operation are contained in Radio Set Case CY-3883/PRC-41. Assemble the straps and harness to the frame, and Radio Receiver Transmitter RT-695/PRC-41 and Storage Battery BB-451/U on the rucksack frame according to the following steps of procedure.

(a) Set the shoulder strap assembly over the top of the rucksack frame and snap in place.

ORIGINAL

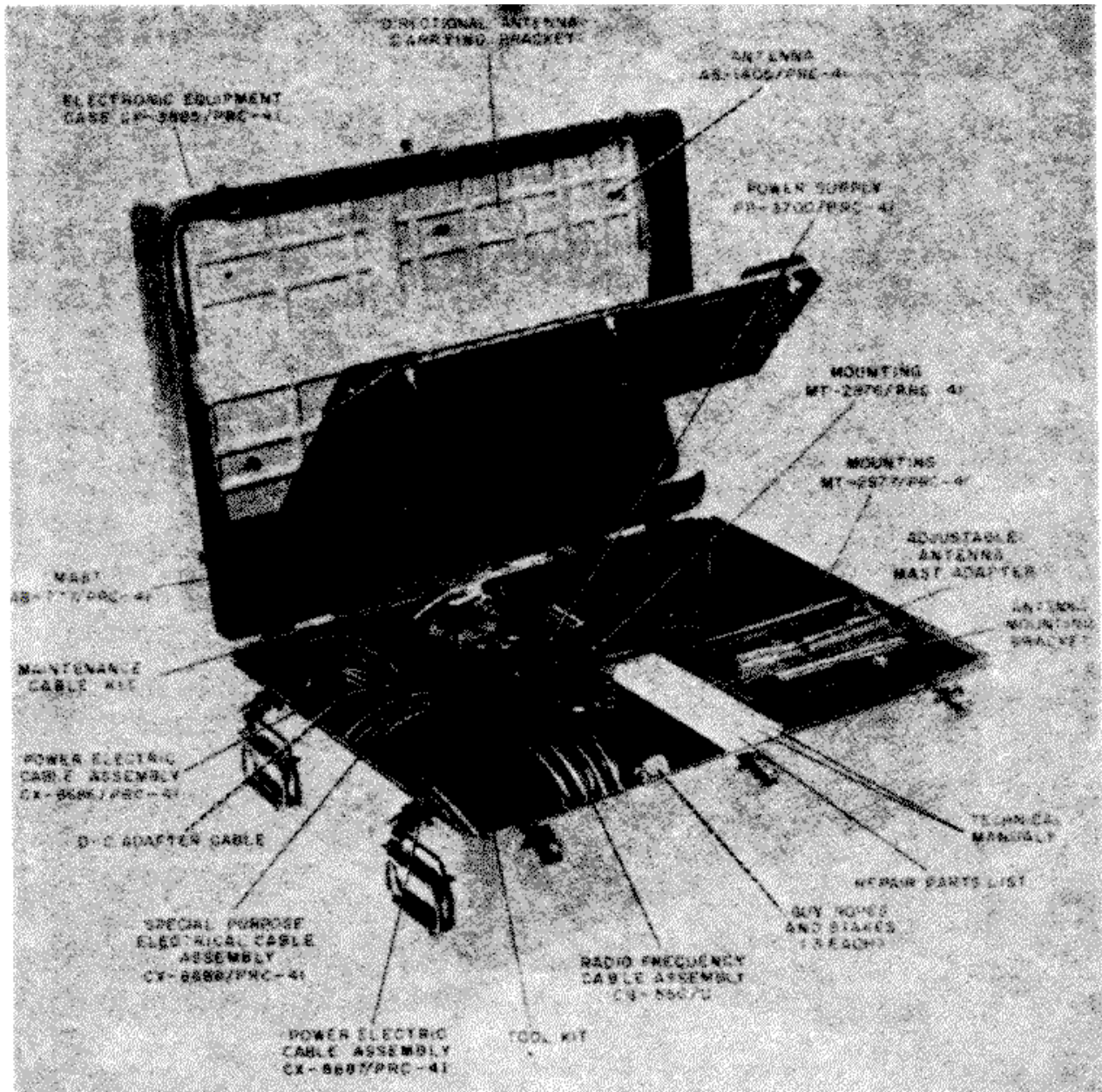

Figure 2-2. Location of Items of Radio Set Accessory Kit MK-706/PRC-41 in Electronic Equipment Case CY-3885/PRC-41

(b) Set the seat strap in place at the bottom of the rucksack frame and tighten up the straps.

(c) Set the retainers of the frame assembly in place on the bottom of the rucksack frame and tighten the two wing nuts. Loop the two take-up straps of the shoulder strap assembly down through the frame assembly and through the take-up brackets on the top frame of the shoulder strap assembly. Do not tighten at this time.

(d) Loop the waist strap through the frame assembly and behind the rucksack frame. Fasten the side straps to the bottom of the rucksack frame.

(e) Clamp Storage Battery BB-451/U to Radio Receiver-Transmitter RT-695/PRC-41. Set them in place on the frame assembly. Secure Radio Receiver-Transmitter RT-695/PRC-41 in place on the rucksack harness by use of the hand set and antenna carrier strapping around the

ORIGINAL

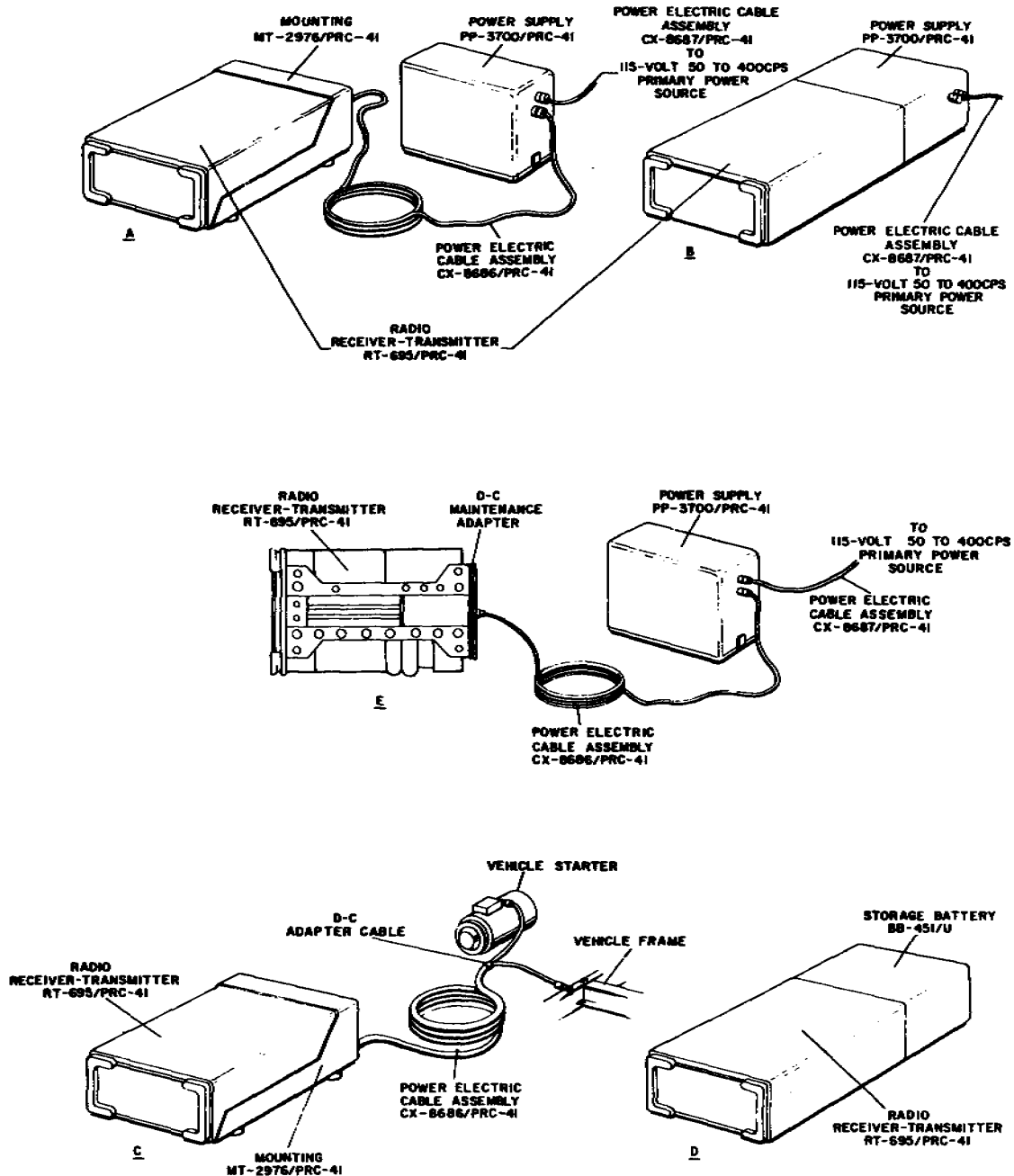

Figure 2-3. Source of Power Configurations of Radio Receiver-Transmitter RT-695/PRC-41

top frame carrier strapping around the top frame of the shoulder strap assembly. Position the lower strap of the handset and antenna carrier strapping around the rucksack frame. Tighten these straps.

(f) Fit the top frame of the shoulder strap assembly over the handles on the front panel of Radio Receiver-Transmitter RT-695/PRC-41 and tighten the take-up straps of the shoulder strap assembly.

(g) Tighten Antenna AS-1404/PRC-41 in place on antenna connector J28 on the front panel of the RT-695/PRC-41 and connect Handset H-33E/ PT to one of the AUDIO connectors. Dress the shoulder straps of the shoulder strap assembly over the operator's shoulders and fasten them to the side straps. Fasten the waist strap at the operator's front and tighten as required. Adjust the shoulder straps for proper fit with the quick-release clamps closed.

ORIGINAL



Figure 2-4. Radio Set AN/PRC-41, Man-Pack Installation

(h) The pack may be removed from the operator's back by unhooking the quick-release fasteners and sliding the straps of the shoulders while the pack is supported from the rear by another man.

(2) STORAGE BATTERY BB-451/U EXCHANGE. - Under a normal 1-minute transmit, 9- receive duty cycle, Storage Battery BB-451/U provides approximately 8 to 10 hours of operation. To replace a discharged Storage Battery BB-451/U by a fully charged one with the equipment stowed on the rucksack frame, perform the following steps of procedure. Refer to figure 2-5.

(a) Remove the pack from the operator's back by unhooking the quick-release fasteners and sliding the straps off the shoulders while the pack is supported from the rear by another man.

(b) Loosen the two straps on the handset and antenna carrier strap, loosen the two take-up straps of the shoulder strap assembly, and separate Radio Receiver-

Transmitter RT-695/PRC-41 and Storage Battery BB-451/U from the rucksack harness.

(c) Unclamp the discharged BB-451/U and replace it with one which is fully charged. Replace the RT-695/PRC-41 and the BB-451/U on the rucksack harness. Tighten the two take-up straps on the shoulder strap assembly and the two straps on the handset and antenna carrier strap.

b. FIXED STATION INSTALLATION. - Refer to figure 2-6. Radio Receiver-Transmitter RT-695/PRC-41 may be supplied power by Power Supply PP-3700/PRC-41, Storage Battery BB-451/U, or by vehicular battery supply for a fixed station installation. A fixed station installation may use either Antenna AS-1404/PRC-41 or AS-1405/PRC-41 mounted on Mast AB-777/PRC-41. Radio Frequency Cable Assembly CG-55G/U must be fitted up through Mast AB-777/PRC-41 and connected to Antenna AS-1405/ PRC-41 or through Adapter

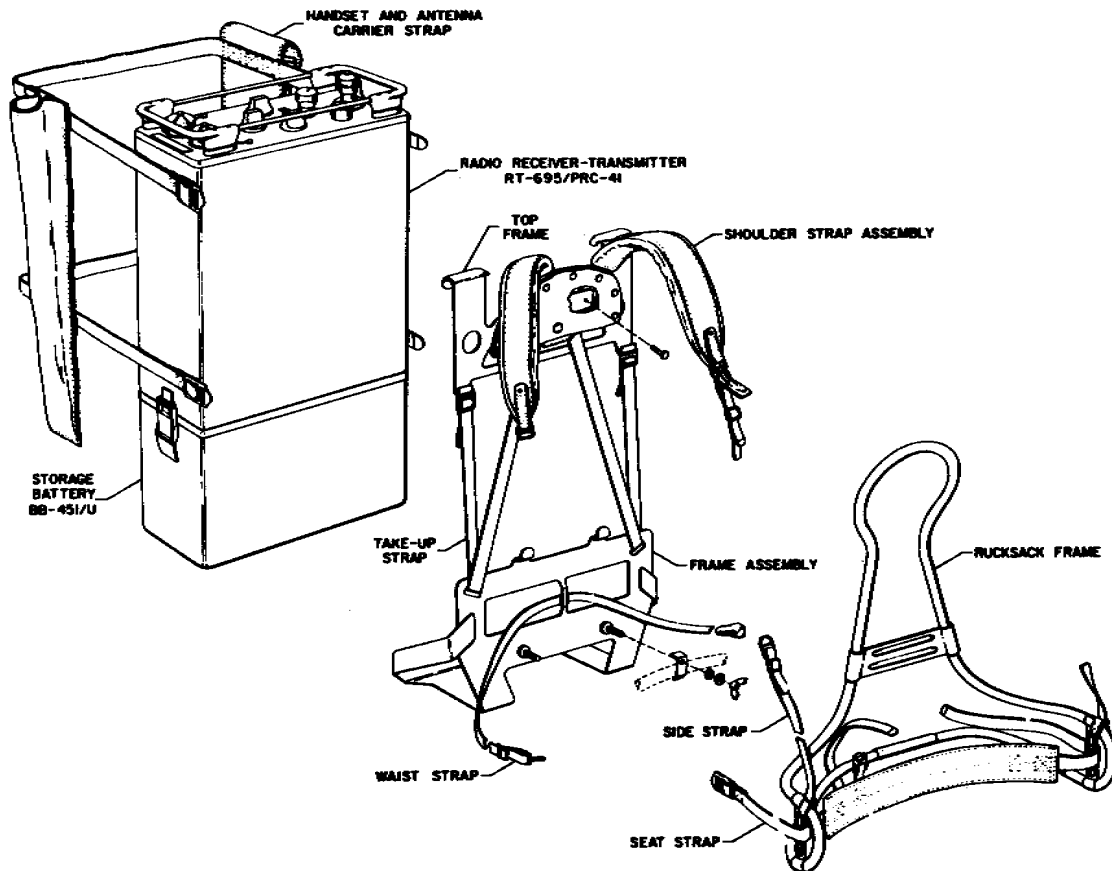

Figure 2-5. Assembly of Strappings of Rucksack Frame for Man-Pack Operation

AS-1404/PRC-41. Connect the other end of Radio Frequency Cable Assembly CG-55G/U to antenna connector J28 on the front panel of the RT-695/PRC-41. Connect Handset H-33E/PT to either of the front panel AUDIO connectors on the RT-695/PRC-41.

(1) ANTENNA MAST INSTALLATION. - Rig the antenna mast according to the following steps of procedure.

(a) Loosen the knurled clasps and fully extend Mast AB-777/PRC-41.

(b) Remove the spike in Mast AB-777/ PRC-41 and stake it in the ground.

(c) Reattach Mast AB-777/PRC-41 to the spike. Arrange the antenna stakes at 120-degree positions about 6 feet from the AB-777/PRC-41. Fasten the snap hooks to the AB-777/PRC -41 and draw up the guy ropes through the guy fasteners.

(d) Pass Radio Frequency Cable Assembly CG-55G/U up through Mast AB-777/PRC-41 to Antenna AS-1405/PRC-41 or through Adapter UG-29B/U to Antenna AS-1404/PRC-41. Set the antenna down into Mast AB-777/PRC-41 and secure in place by tightening the screw clamp.

c. VEHICULAR OR AIRCRAFT INSTALLATION.

Refer to figure 2-7.

(1) MOUNTING AND POWER CONSIDERATIONS. - When Radio Receiver-Transmitter RT-695/ PRC-41 is used in a vehicular installation, it is mounted on Mounting MT-2976/PRC-41 and supplied power through Power Electric Cable Assembly CX-8686/PRC-41 and the dc adapter cable from the vehicle battery supply. Refer to part C of figure 2-3. Refer to figures 2-13 and 2-16 for outline and mounting dimensions when fastening the shockmounts of Mounting MT-2976/PRC-41 to the vehicle. When the RT-695/PRC-41 is used in an aircraft, it is mounted in the same way as for a vehicular installation. Power for an aircraft installation is supplied by Power Supply PP-3700/PRC-41 which may be located at some remote location in the aircraft. Power Supply PP-3700// PRC-41 clamps to Mounting MT-2977/PRC-41. Mounting MT-2977/PRC-41 must be secured to the aircraft frame. Refer to figures 2-14 and 2-17 for outline and mounting dimensions. Power Electric Cable Assembly CX-8687/PRC-41 connects Power Supply PP-3700/PRC-41 to the 115-volt, 50- to 400- primary aircraft supply. Power Electric Cable Assembly CX-8686/PRC-41 is used to connect Power Supply PP-3700/PRC-41 to Mounting MT-2976/ PRC-41 to supply power to the RT-695/PRC-41.

ORIGINAL

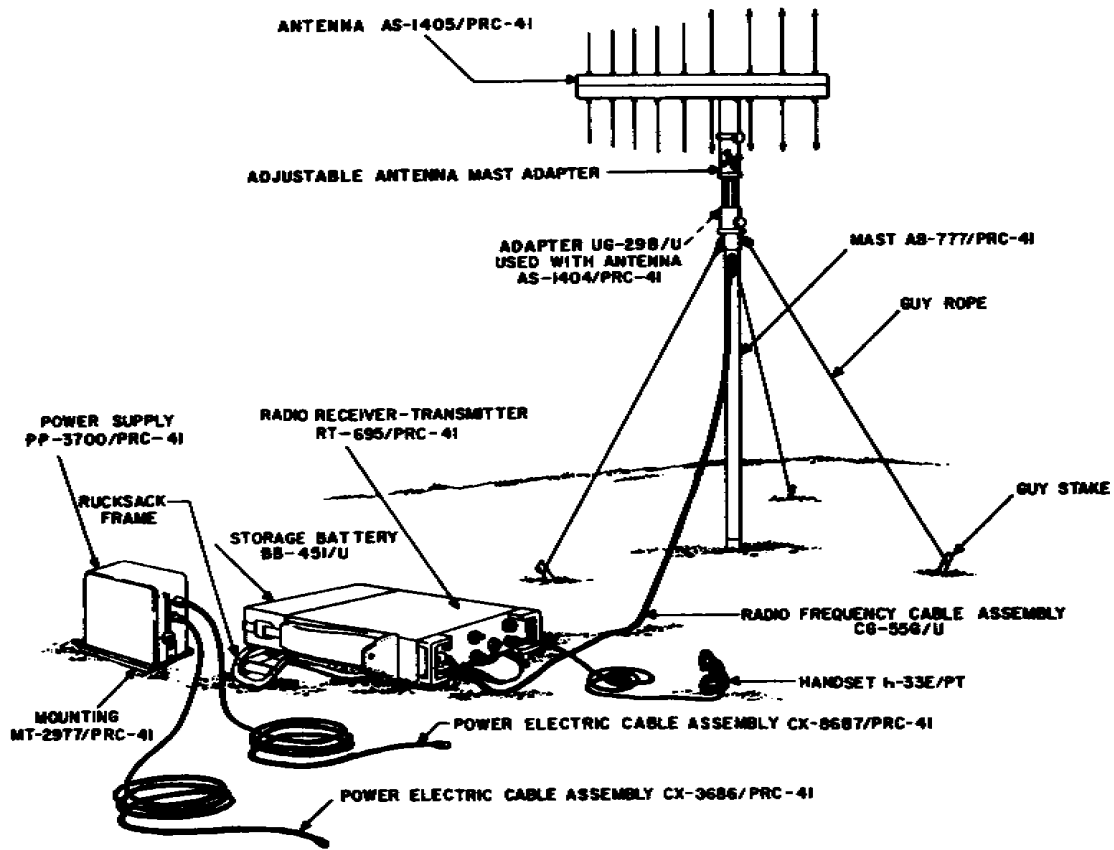

Figure 2-6. Radio Set AN/PRC-41. Fixed Station Installation

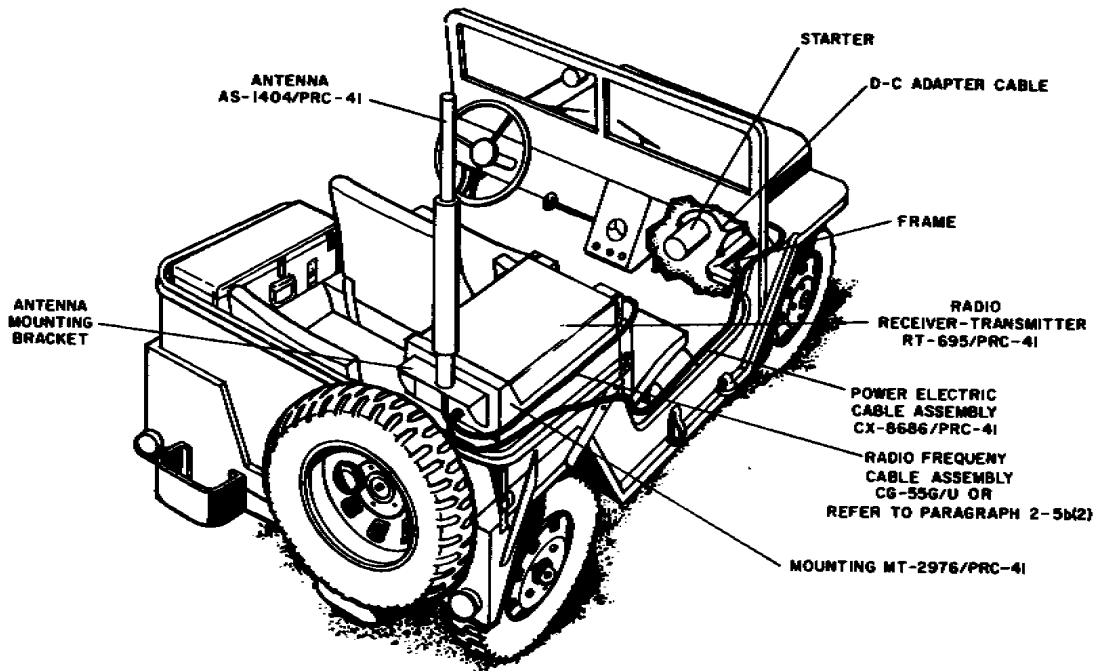

Figure 2-7. Radio Set AN/PRC-41, Vehicular Installation

(2) ANTENNA CONSIDERATIONS. - When Radio Receiver-Transmitter RT-695/PRC-41 is installed in a vehicular or aircraft installation, it is secured to Mounting MT-2976/PRC-41 and used with Antenna AS-1404/PRC-41. The antenna mounting bracket normally fastens to the rear of Mounting MT-2976/PRC-41 to permit vertical mounting of Antenna AS-1404/PRC-41. Radio Frequency Cable Assembly CG-55G/U connects between the connector on the antenna mounting bracket and antenna connector J28 on the front panel of Radio Receiver-Transmitter RT-695/PRC-41.. Because Radio Frequency Cable Assembly CG-55G/U is a 20-foot length, it may be more convenient to fabricate a shorter length for this installation. Refer to paragraph 2-5b(2) for fabrication instructions. The four screws indicated by figure 2-16 may be removed from the rear of Mounting MT-2976/PRC-41 and used to secure the antenna mounting bracket to the rear of the MT-2976/PRC-41. If it is desirable to mount the antenna mounting bracket on some other flat vertical surface, use the antenna mounting bracket mounting holes as a template, scribe their location on the mounting surface, drill four 5/32-inch holes at the scribed positions, and secure the antenna mounting bracket by use of four 6-32 metal screws or bolts

d. AUTOMATIC RELAY INSTALLATION. Automatic relay operation requires two Radio Receiver-Transmitter RT-695/PRC-41 installations. The installations may be fixed station, vehicular, or man-pack. The automatic

relay installation is completed by connecting Special Purpose Electrical Cable Assembly CX-8688/PRC-41 between one of the front panel connectors marked AUDIO on one of the RT-695/PRC-41 equipments and one of the AUDIO connectors on the front panel of a second RT-695/PRC-41. Transmission or monitoring may take place at the automatic relay installation by connecting Handset H-33E/PT to an available front panel AUDIO connector on one of the RT-695/PRC-41 equipments. In this type of operation, two Radio Receiver-Transmitter RT-695/PRC-41 equipments are connected so that reception of a signal of the frequency to which either RT-695/PRC-41 is tuned will result in retransmission of the signal on the frequency to which the other RT-695/PRC-41 is tuned.

(1)DESCRIPTION OF AUTOMATIC RELAY INSTALLATION. - Automatic relay operation makes possible several tactical advantages. By using a station which has two RT-695/PRC-41 equipments connected for automatic relay operation with any uhf transmitter and receiver, or other RT-695/PRC-41 equipment, the line-of-sight distance, which ordinarily limits the range of uhf equipment, can be considerably increased. A diagram illustrating the use of automatic relaying operation is shown in figure 2-8. In this illustration, any signal transmitted by C can be received at A after being automatically relayed at B. Conversely, any signal transmitted from A can be received at C after being automatically relayed at B.

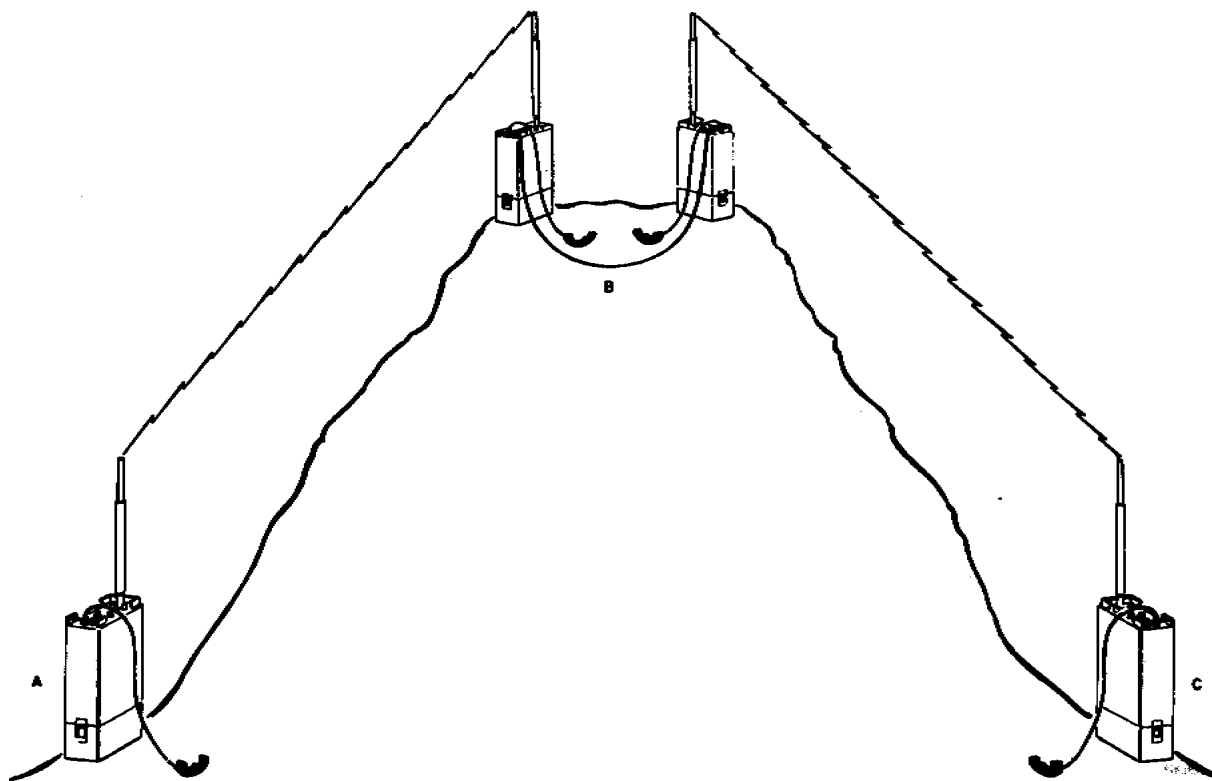

Figure 2-8. Principle of Automatic Relay Operation

Several such relay links may be possible. but in each case, retransmission must always be on a frequency other than that received.

A simplified schematic diagram of the automatic relay circuitry is shown in figure 2-9. Assume that Radio Receiver-Transmitter RT-695/PRC-41 number 1 is receiving a signal on a particular frequency. Relay 1A3K1 of the 3rd i-f and squelch module of the RT-695/PRC-41 number 1 is energized by the carrier squelch circuits. The contacts of relay 1A3K1 provide a ground for relay 1A9K5 on the main chassis and it is energized. The contacts of relay 1A9K5 provide a ground through pin K of J14. through Special Purpose Electrical Cable Assembly CX-8688/PRC-41. through pin F on J13 of the RT-695/PRC-41 number 2 to the RT-695/PRC-41 relays 1A9K1, 1A9K3, and 1A9K4. These relays are energized and place the RT-695/ PRC-41 number 2 in transmit operation. The audio output from the RT-695/PRC-41 number 1 is applied through pin A of J14 through Special Purpose Electrical Cable Assembly CX-8688/PRC-41.. through pin C of J13 on the RT-695/PRC-41 number 2. to the modulator module and is transmitted by the RT-695/PRC-41 number 2. The sidetone circuits sample the modulator output and couple this signal through the contacts of main chassis relay K4 to the input of the audio module. The sidetone output from the audio module is available to pins A of J13 and J14 and may be heard in the headset connected to J14 of the RT-695/PRC-41 number 2 through pin A of J14. The sidetone output through pin A of J13. through the CX-8688/PRC-41, through pin C of J14 on the RT-695/PRC-41 number 1 to the modulator input, is of no consequence to the RT-695/PRC-41 number 1 since there is no voltage applied to the modulator. The operation when the RT-695/PRC-41 number 2 is in receive is, except for pin numbers and connection points, the reverse of this theory of operation. Whether the RT-695/ PRC-41 number 1 or number 2 is first to receive on its respective

frequency determines which will control the other into transmit condition. Relay 1A9K6 of the main chassis allows compatible operation with Control Group AN/GRA-6.

With two Radio Receiver-Transmitter RT-695/ PRC-41 equipments connected by Special Purpose Electrical Cable Assembly CX-8688/PRC-41 and a Handset H-33E/PT connected to each one of these, transmission may be made on either equipment by use of its respective handset. When the press-to-talk button is depressed on Handset H-33E/PT, a ground is provided main chassis relays 1A9K1, 1A9K3, and 1A9K4 of the RT-695/PRC-41 number 2, and it is placed in the transmit condition. Refer to figure 2-9. Relay 1A9K5 of the RT-695/PRC-41 number 1 is energized when this RT-695/PRC-41 is receiving a signal and, therefore, it does not provide the ground for relays of the RT-695/PRC-41 number 2 unless a signal is being received. Relay 1A9K5 of the RT-695/PRC-41 number 2 is not energized because the 24.5-volt d-c supply is removed from the 3rd i-f and squelch module and its relay 1A3K1 cannot be energized. The sidetone circuits sample the modulator module output of the RT-695/PRC-41 number 2 and couple this signal through contact 3 of main chassis relay 1A9K4 to the input of the audio module. The sidetone output from the audio module is available to pins A of J13 and J14 and may be heard in the headset connection to J14 of the RT-695/PRC-41 number 2. The sidetone output through pin A of J13 (on the RT-695/PRC-41 number 2), is applied through the CX-8688/PRC-41, and through pin C of J14 (on the RT-695/PRC-41 number 1) to the modulator module. This is of no consequence since the RT-695/PRC-41 number 1 is in the receive condition. The same conditions exist if the RT-695/PRC-41 number 1 is keyed.

2-5. CABLE ASSEMBLIES.

a. GENERAL. - The cables required for man-, fixed, or vehicular installations are listed in table 2-1. These cables are supplied as part of Radio Set Accessory Kit MK-706/PRC-41.

TABLE 2-1. CABLES SUPPLIED WITH RADIO SET ACCESSORY KIT MK-706/PRC-41

CABLE*	LOAD REQUIREMENTS	ACTIVE CONDUCTORS	LENGTH (feet)
Radio Frequency Cable Assembly CG-55G/U	8.5 amp max	RG-213/U	20
Power Electric Cable Assembly CX-8686/PRC-41	15 amp max	3	20
Power Frequency Cable Assembly CG-55G/U CX 8687/PRC-41	15 amp	3	50
Special Purpose Electrical Cable Assembly CX-8688/PRC-41	3 amp	7	10
D-c adapter cable	15 amp	2	1
*Refer to table 1-4 for information pertaining to cables of the maintenance cable kit.			

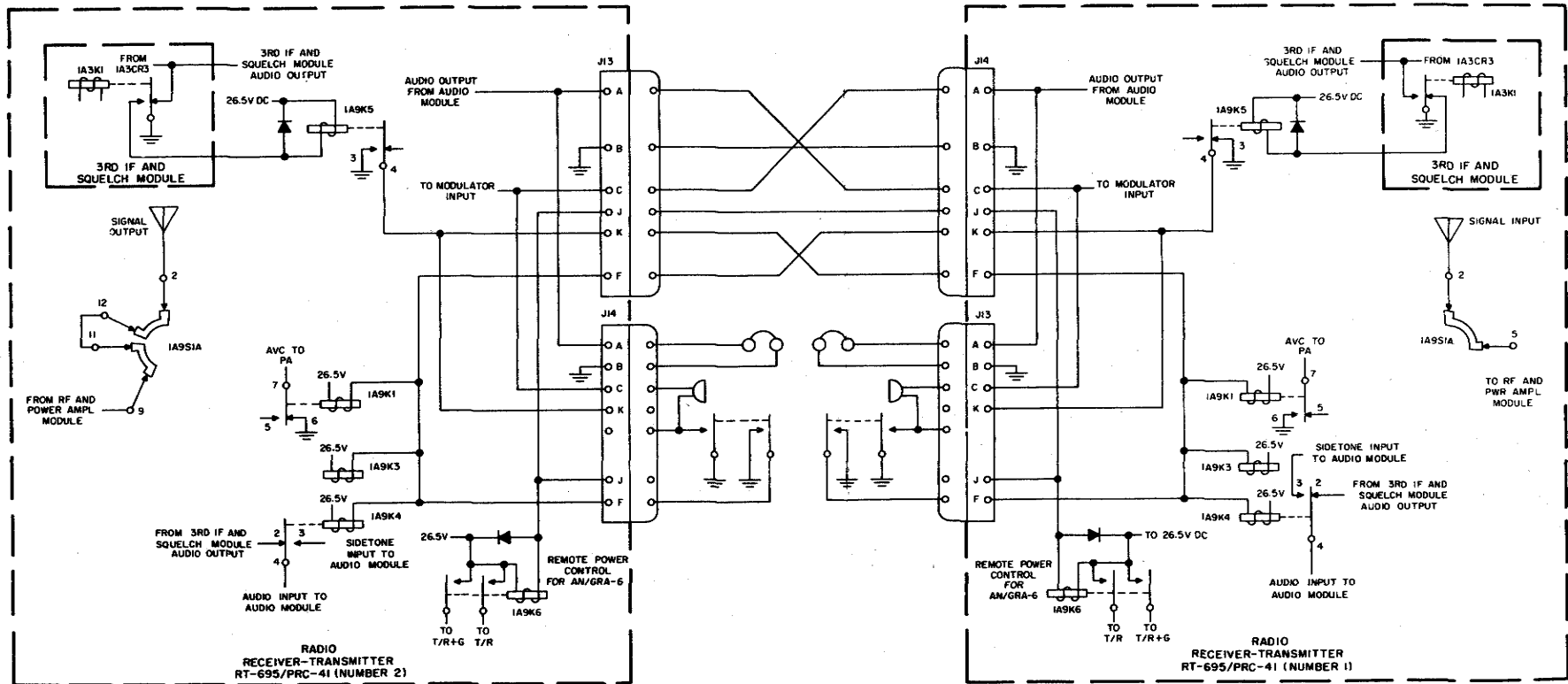

Figure 2-9. Automatic Relay Operation, Simplified Schematic Diagram

2-9/(2-10 blank)

Set Accessory Kit MK-706/PRC-41. In addition to the cables listed in table 2-1, it may be desirable to fabricate the a-c power and radio frequency coaxial cables which are described in paragraph 2-5b.

b. FABRICATION OF SPECIAL CABLES.

(1) 230-VOLT POWER CABLE. - Power transformer T1 of Power Supply PP-3700/PRC-41 has a split primary. Terminals 1 and 2 of transformer T1 are connected to pins A and F of power connector J1. Terminals 3 and 4 of transformer T1 are connected respectively to pins D and C of connector J1. The connector of Power Electric Cable Assembly CX-8687/PRC-41 which mates with power connector J1 of Power Supply PP-3700/PRC-41 is wired for use with a 115-volt, 50- to 400-cps primary power source. Refer to figure 1-11. In event that only 230-volt, 50- 400-cps primary power is available, the a-c power cable described by figure 2-10 may be fabricated from bulk supplies. This cable differs from Power Electric Cable Assembly CX-8687/PRC-41 in that connector P1 is a three-prong, 230-volt, twist-lock plug and plug P2 is wired so as to connect the two primary sections of PP-3700/PRC-41 power transfer T1 in series.

(2) RADIO FREQUENCY COAXIAL CABLE. - Normally when it becomes necessary to connect an antenna to

antenna connector J28 on the front panel of Radio Receiver-Transmitter RT-695/PRC-41 through a cable, Radio Frequency Cable Assembly CG-55G/U is used. In a vehicular, and in some cases a fixed station, installation where Antenna AS-1404/PRC-41 (omnidirectional) is used on the antenna mounting bracket, the length of the CG-55G/U is excessive and cumbersome. For this application, the radio frequency coaxial cable illustrated in figure 2-11 may be desirable. Refer to figure 2-12 for assembly of connectors MS91236 on RG-8/U coaxial cable.

2-6. INSPECTION AND ADJUSTMENT.

Inspect Radio Set AN/PRC-41 by performing the operating procedures of paragraph 3-3 and by making visual checks for evidence of damage. No additional installation adjustments are required.

2-7. INTERFERENCE REDUCTION.

Under normal conditions of installation and operation, radio interference generated by Radio Set AN/ PRC-41 and its susceptibility to radio interference is controlled within the limits of military specification MIL-1-16910.

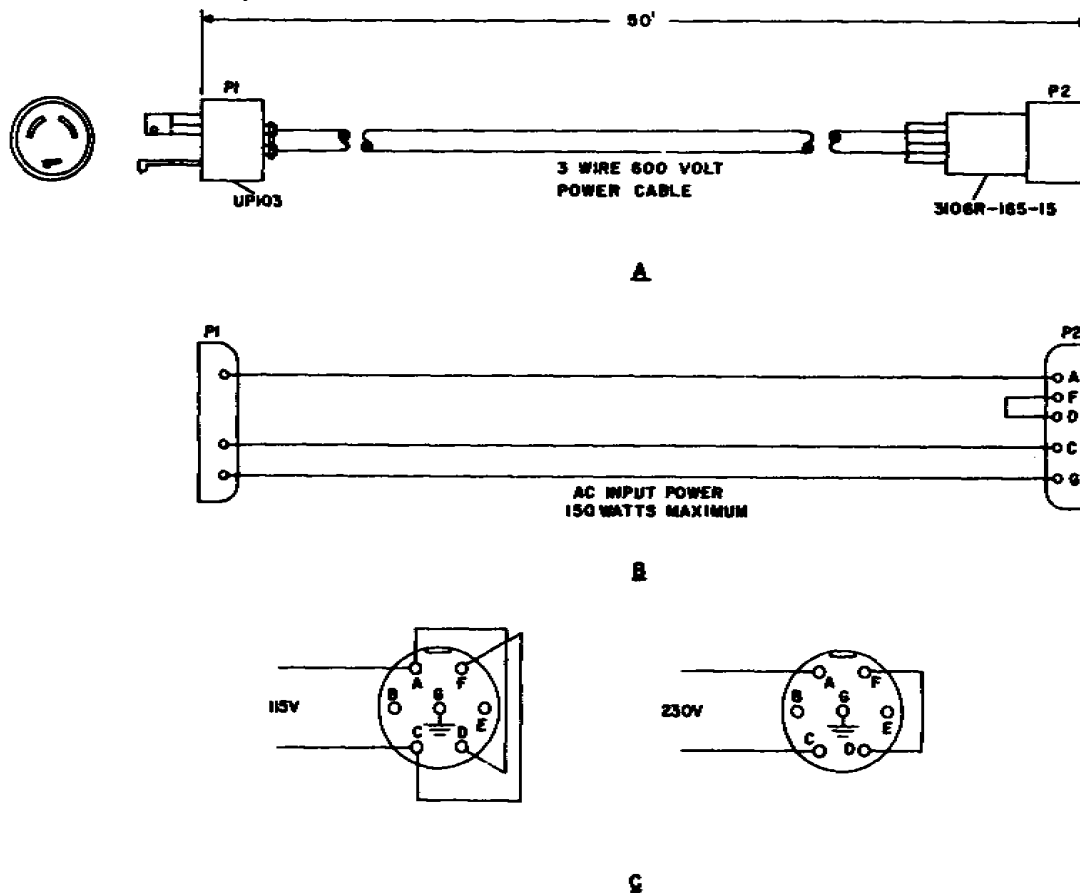

Figure 2-10. 230 Volt Power Cable, Fabrication Diagram

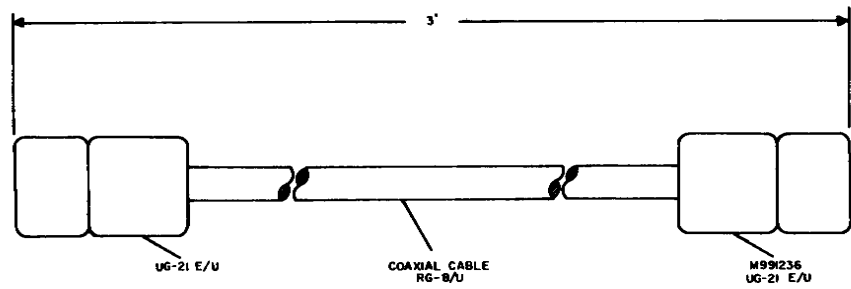

Figure 2-11. Radio Frequency Coaxial Cable, Fabrication Diagram

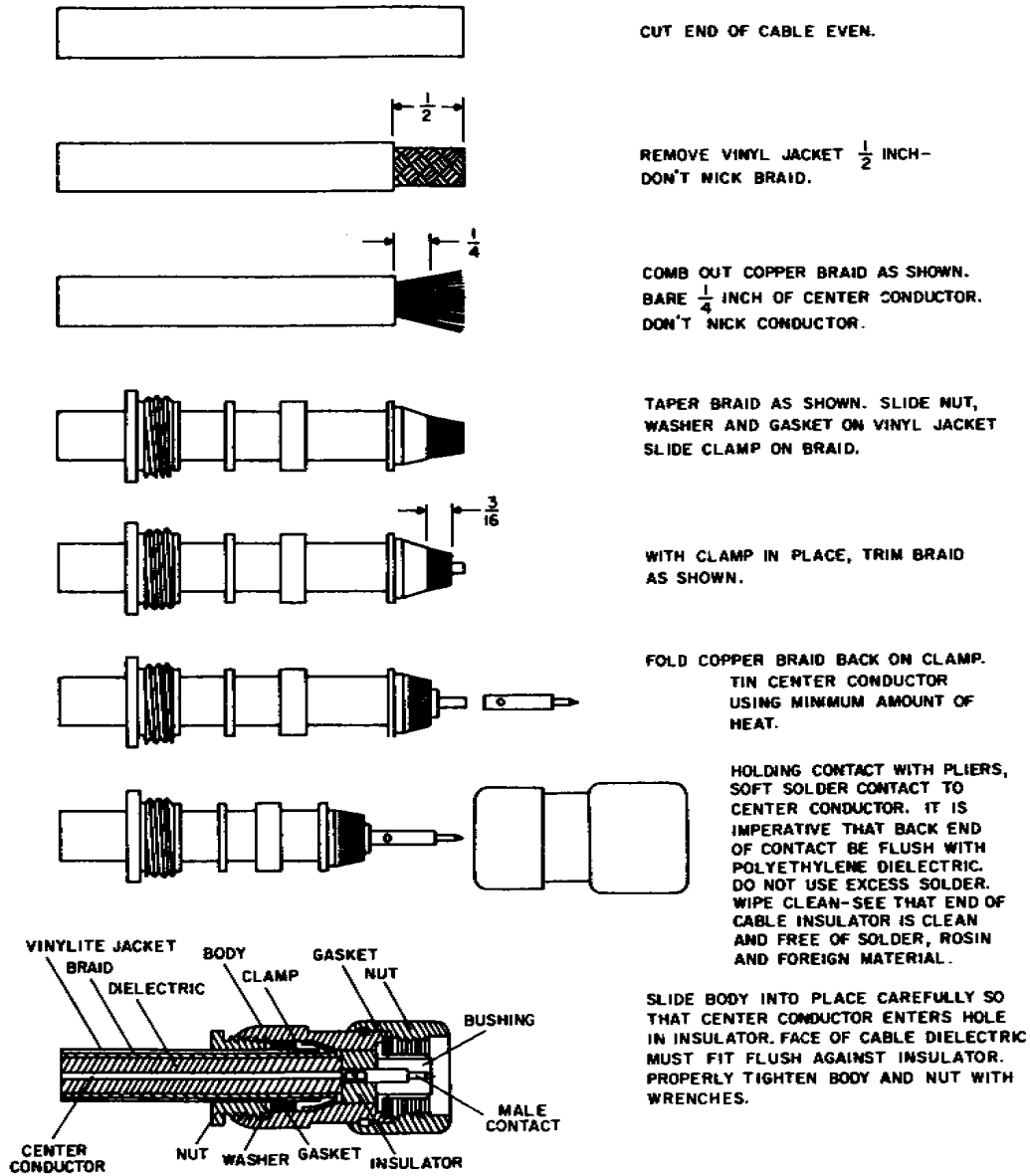

Figure 2-12. Assembly of Type RG-8/U Connector

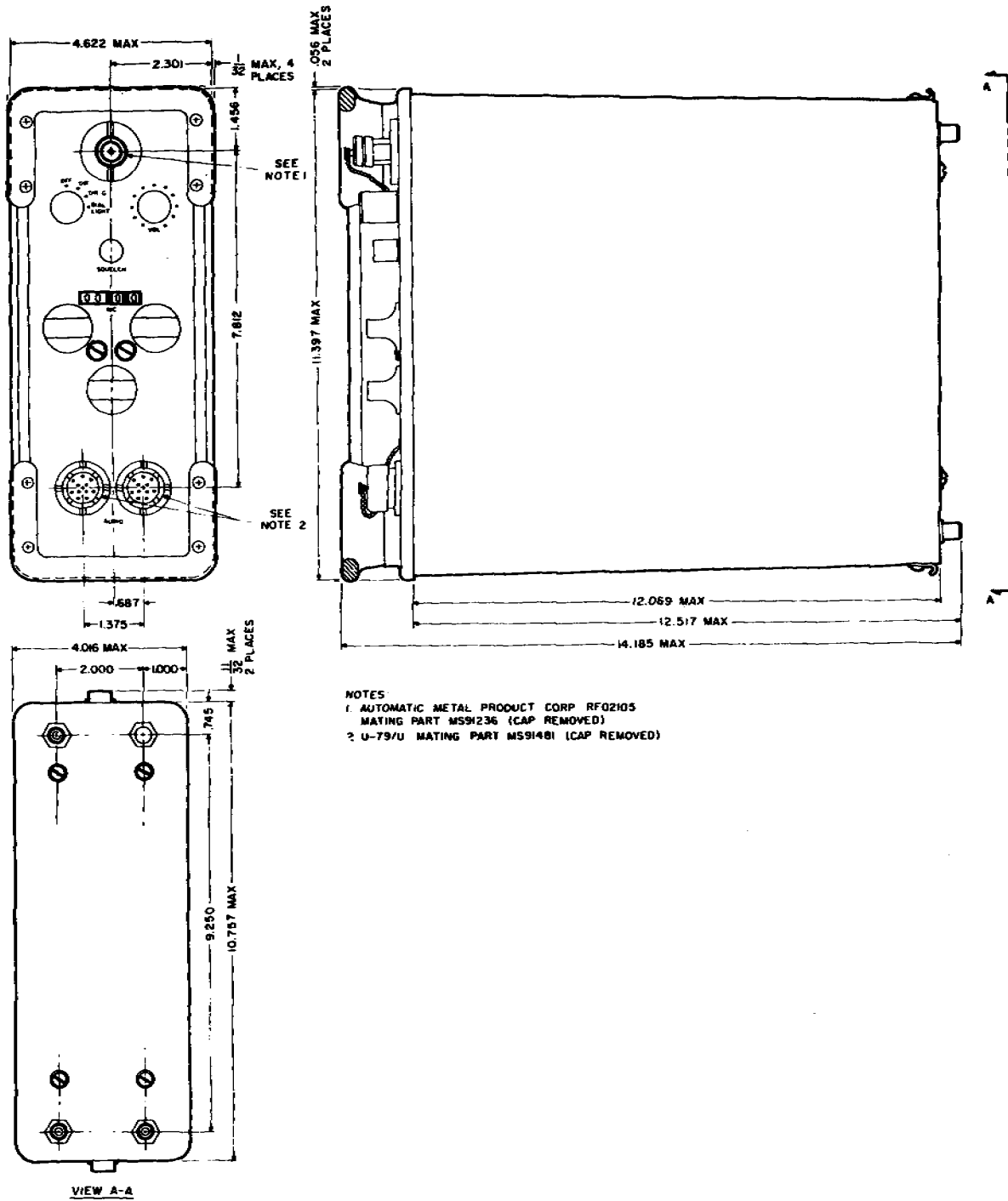

Figure 2-13. Radio Receiver-Transmitter RT-695/PRC-41, Outline and Mounting Dimensions

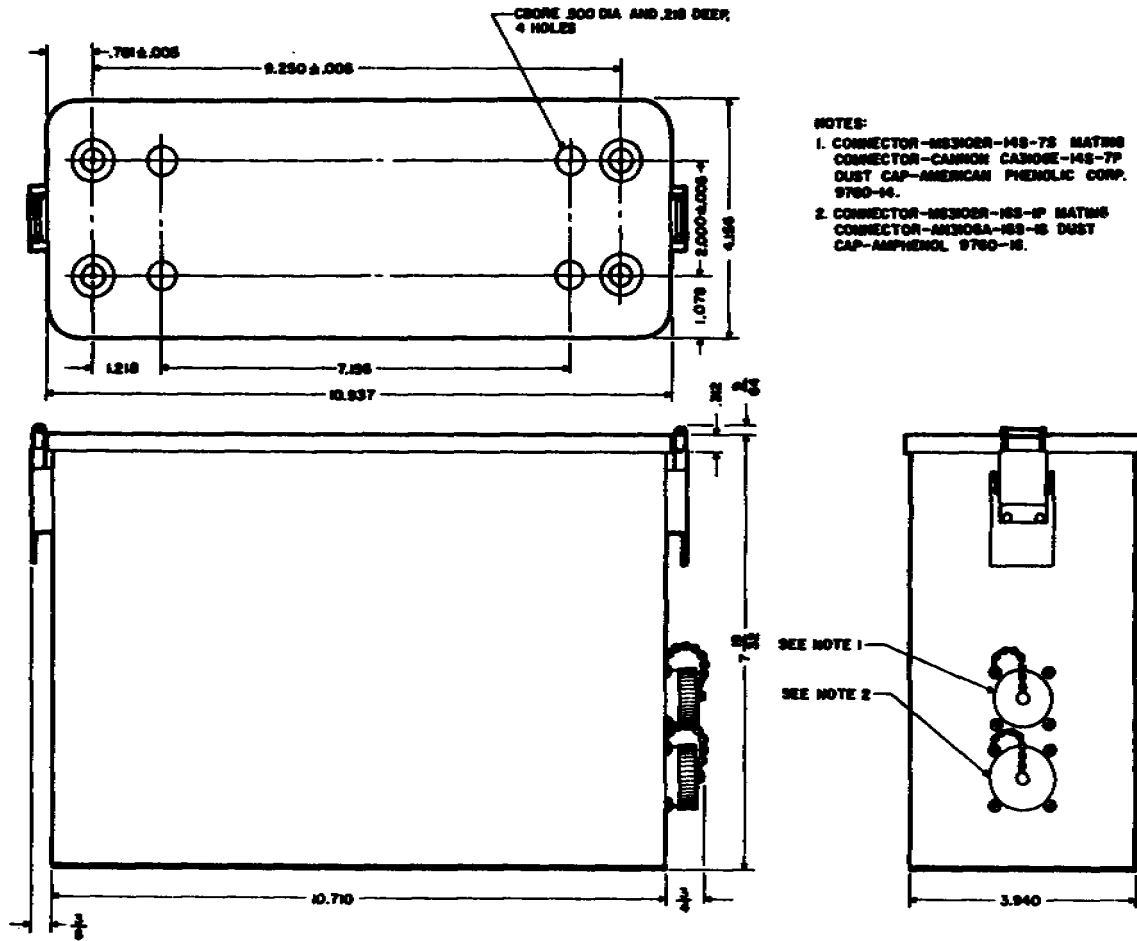

Figure 2-14. Power Supply PP-3700/PRC-41, Outline and Mounting Dimensions

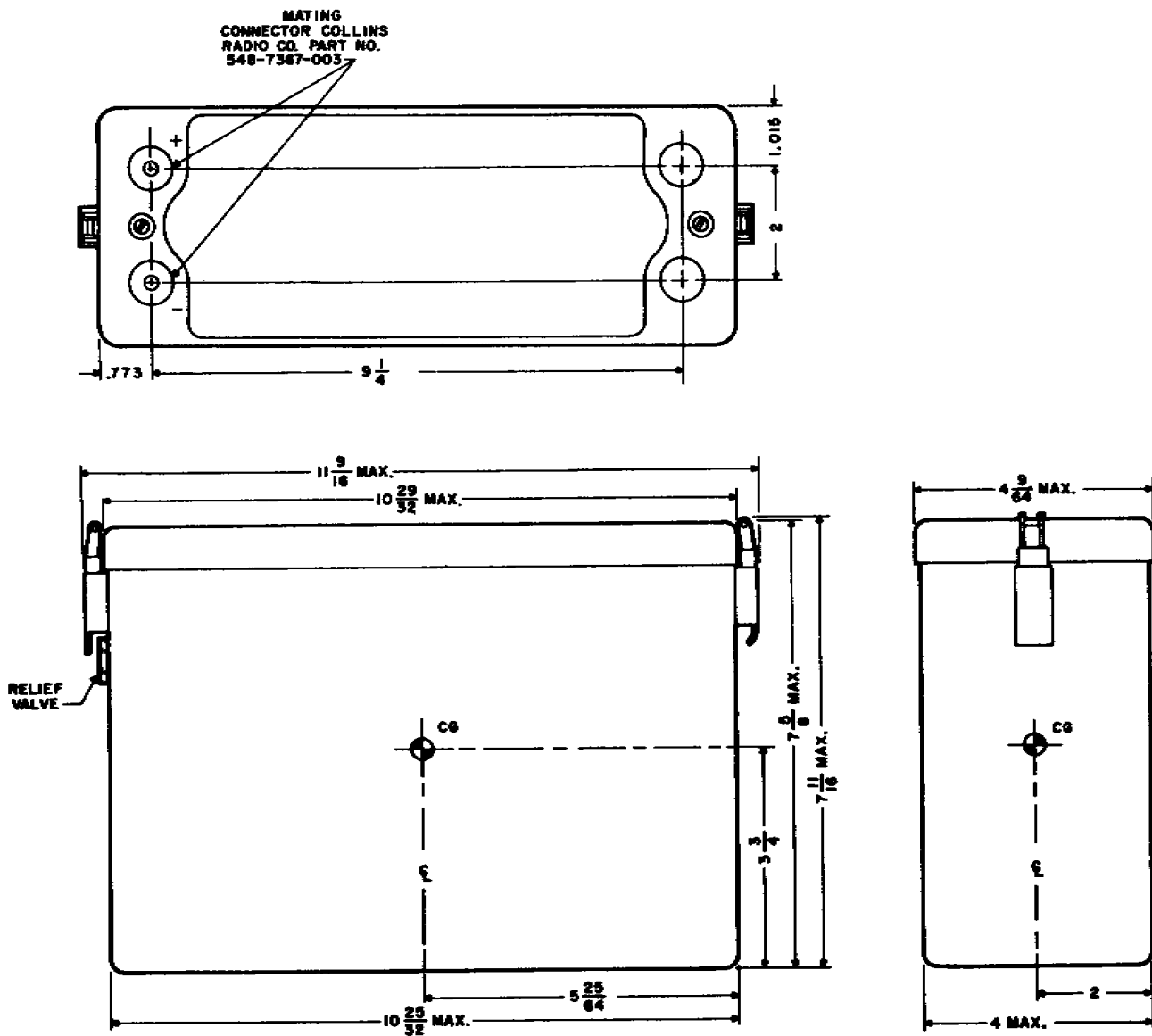

Figure 2-15. Storage Battery BB-451/U. Outline and Mounting Dimensions

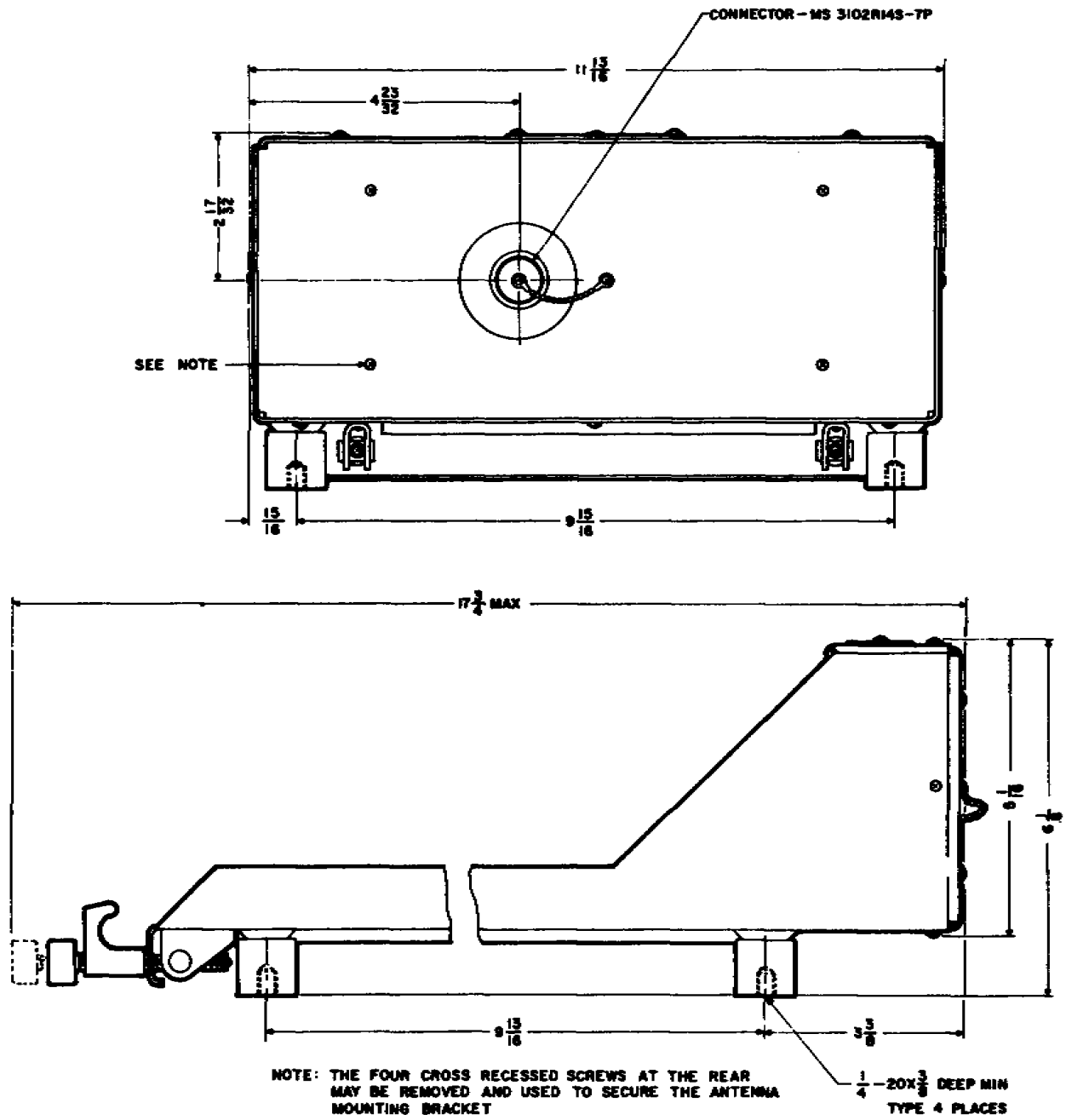

Figure 2-16. Mounting MT-2976/PRC-41, Outline and Mounting Dimensions

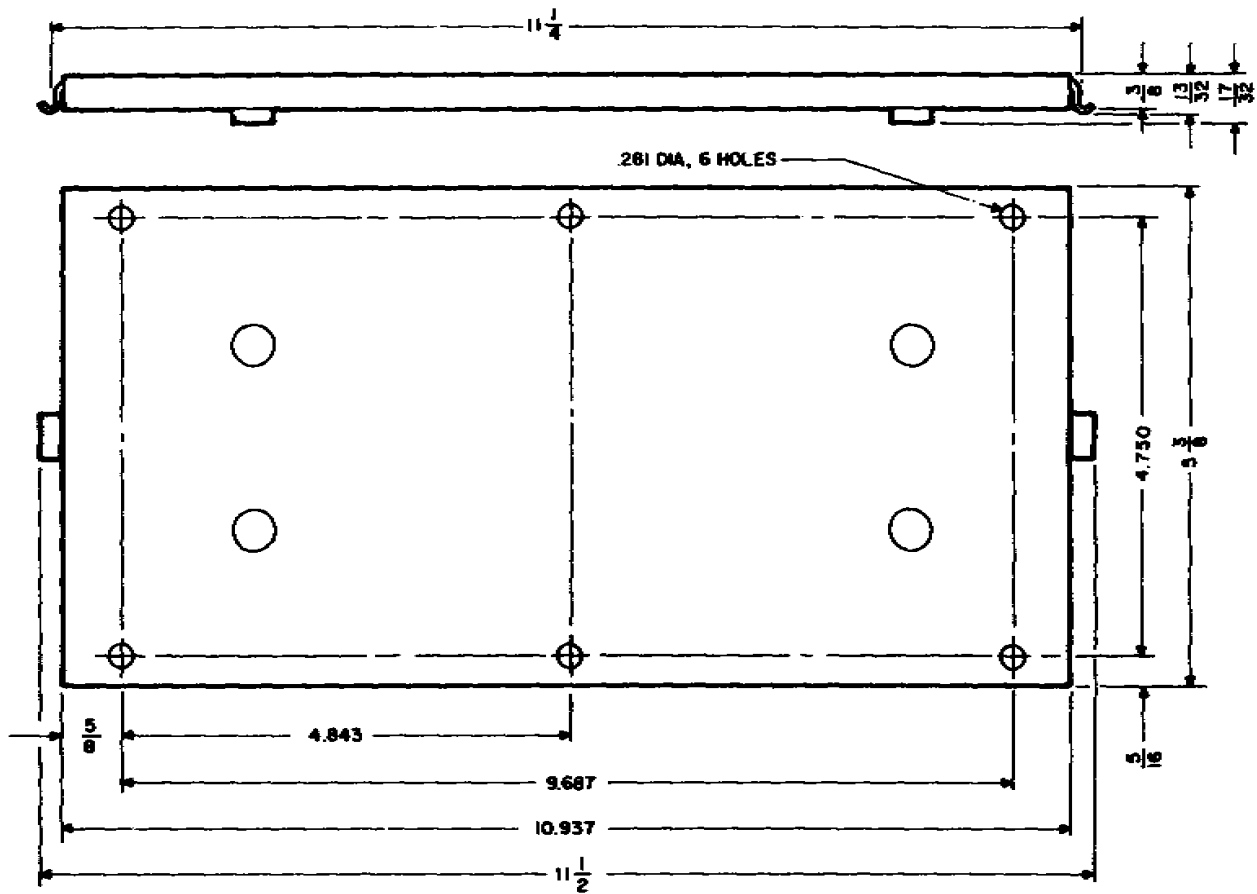

Figure 2-17. Mounting MT-2977/PRC-41. Outline and Mounting Dimensions

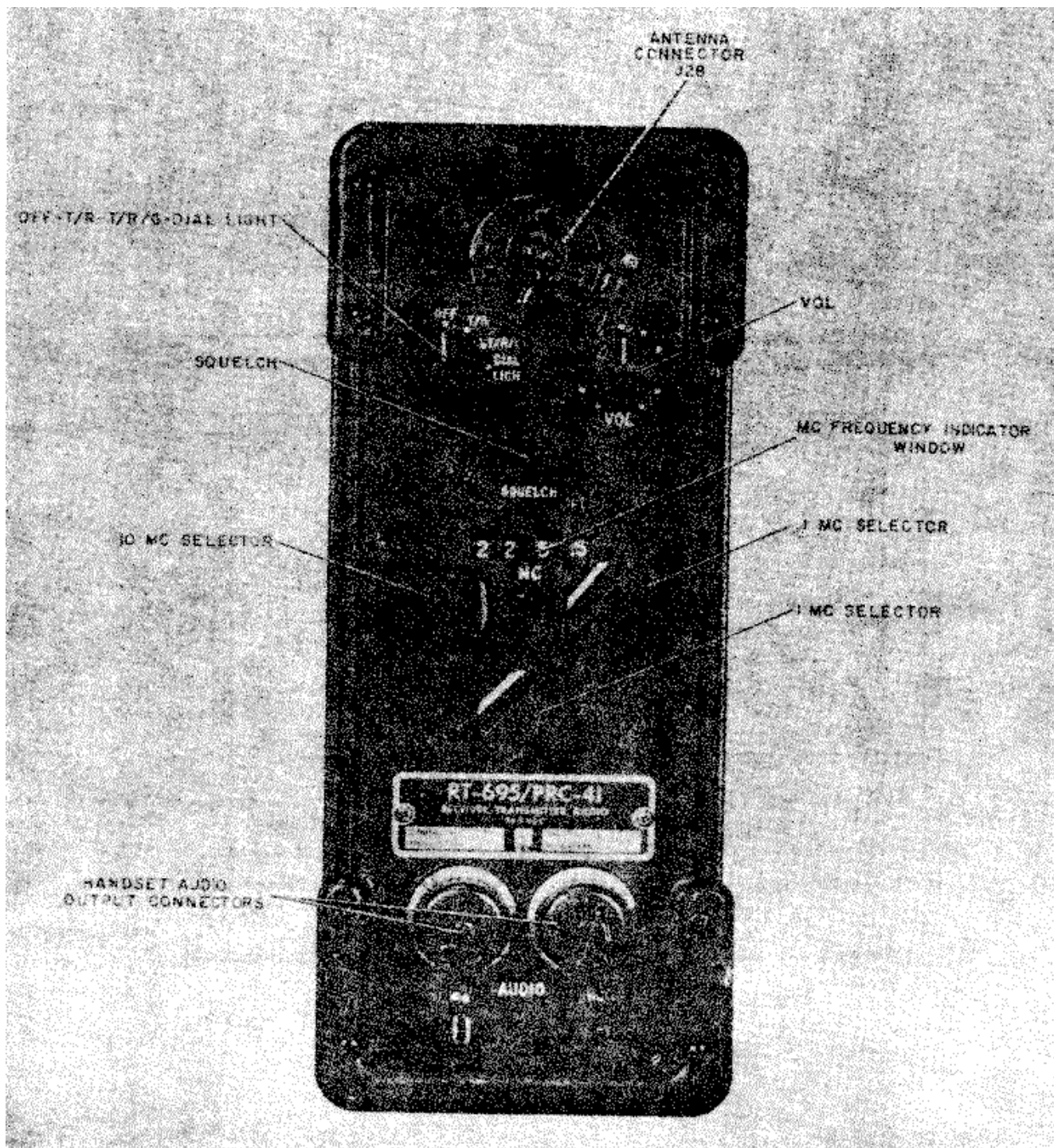

Figure 3-1. Radio Receiver-Transmitter RT-695/PRC-41., Front Panel Controls

SECTION 3

OPERATION

3-1. PREPARATION FOR USE

The units and accessories of Radio Set AN/PRC-41 which are listed in tables 1-1 and 1-2 permit use of the equipment in various configurations (fig. 1-1). Not all of the equipment is used for a particular installation. Refer to section 2 for installation instructions.

3-2. CONTROLS, CONNECTORS, AND INDICATOR.

All operating controls are located on the front panel of Radio Receiver- RT-695/PRC-41. Table 3-1 lists their functions.

TABLE 3-1. CONTROLS, CONNECTORS, AND INDICATOR FUNCTIONS

CONTROL, CONNECTOR OR INDICATOR	FUNCTION								
OFF-T/R-T/R/G-DIAL LIGHT switch	Four-position switch that selects mode of operation. Switch positions are: <table data-bbox="688 890 1398 1203"><thead><tr><th data-bbox="688 890 764 915"><u>Sw pos</u></th><th data-bbox="987 890 1073 915"><u>Function</u></th></tr></thead><tbody><tr><td data-bbox="688 947 737 972">OFF</td><td data-bbox="797 947 1084 972">Turns off the RT-695/PRC-41</td></tr><tr><td data-bbox="688 1003 732 1029">T/R</td><td data-bbox="797 1003 1398 1087">Turns on the RT-695/PRC-41, ready for main receiver reception. For transmission, the press-to-talk button on the H-33E/PT must be pressed.</td></tr><tr><td data-bbox="688 1119 753 1144">T/R/G</td><td data-bbox="797 1119 1398 1203">Turns on the RT-695/PRC-41, ready for main receiver reception and transmission. This position permits reception on the guard receiver at the same time.</td></tr></tbody></table>	<u>Sw pos</u>	<u>Function</u>	OFF	Turns off the RT-695/PRC-41	T/R	Turns on the RT-695/PRC-41, ready for main receiver reception. For transmission, the press-to-talk button on the H-33E/PT must be pressed.	T/R/G	Turns on the RT-695/PRC-41, ready for main receiver reception and transmission. This position permits reception on the guard receiver at the same time.
<u>Sw pos</u>	<u>Function</u>								
OFF	Turns off the RT-695/PRC-41								
T/R	Turns on the RT-695/PRC-41, ready for main receiver reception. For transmission, the press-to-talk button on the H-33E/PT must be pressed.								
T/R/G	Turns on the RT-695/PRC-41, ready for main receiver reception and transmission. This position permits reception on the guard receiver at the same time.								

TABLE 3-1. CONTROLS, CONNECTORS, AND INDICATOR FUNCTIONS (cont)

CONTROL, CONNECTOR, OR INDICATOR	FUNCTION
	Function
DIAL LIGHT	Turns on the RT-695/PRC-41, illuminates the MC frequency indicator window, and also turns on the RT-695/PRC-41, ready for reception and transmission, and will pick up signals on the guard receiver. When the switch control is released, it will spring back to the T/R/G position
SQUELCH control	Variable control that determines receiver quieting and sets the noise level that will squelch the receiver output.
VOL control	Enables operator to change the audio level in the H-33E/PT.
MC frequency indicator	Indicates frequency of operation.
10 mc selector switch	Selects numbers 22 through 39 in the MC window and tunes the RT-695/PRC-41 within 10 mc of the desired frequency.
1 mc elector switch	Selects numbers 0 through 9 in the MC window and tunes the RT-695/PRC-41 to within 1 mc of the desired frequency.
1 mc selector switch	Selects numbers 0.0 through 0.9 in the MC window and tunes the RT-695/PRC-41 to the exact desired frequency.
Antenna connector	Mates with Antenna AS-1404/PRC-41 or Antenna AS-1405/PRC-41 connector plug.
AUDIO connectors	Either connector mates with the H-33E/PT plug.

3-3. OPERATING PROCEDURES (fig. 3-1).

Note: Transmission and reception will always be on the same frequency.

a. MAIN RECEIVER RECEPTION. - Turn the OFF-T/R-T/R/G-DIAL LIGHT switch to the T/R position. The main receiver is now ready for reception in the range of 225.0 to 399.9 mc.

- (1) Turn the three selector controls until the desired frequency appears on the MC frequency indicator window.
- (2) Rotate the SQUELCH control counterclockwise until noise is heard in Handset H-33E/PT; then rotate it clockwise until the noise just disappears.
- (3) Adjust the audio output heard in Handset H-33E/PT to a comfortable level by rotating the VOL control.
- (4) Turn the OFF-T/R-T/R/G-DIAL LIGHT switch to the OFF position.

b. GUARD RECEIVER RECEPTION.

- (1) Turn the OFF-T/R-T/R/G-DIAL LIGHT switch to the T/R/G position.
- (2) Set the other controls as in (1) through (3) above.

c. TRANSMISSION. - Turn the OFF-T/R-T/R/G-DIAL LIGHT switch to the T/R or the T/R/G position.

- (1) Turn the three selector controls to the desired frequency.
- (2) Press the press-to-talk button on Handset H-33E/PT and talk into the microphone.

d. AUTOMATIC RELAY OPERATION. - Refer to figure 2-8 and paragraph 2-4d. Except for operating frequencies, each RT-695/PRC-41 is operated in accordance with instructions in a through c above.

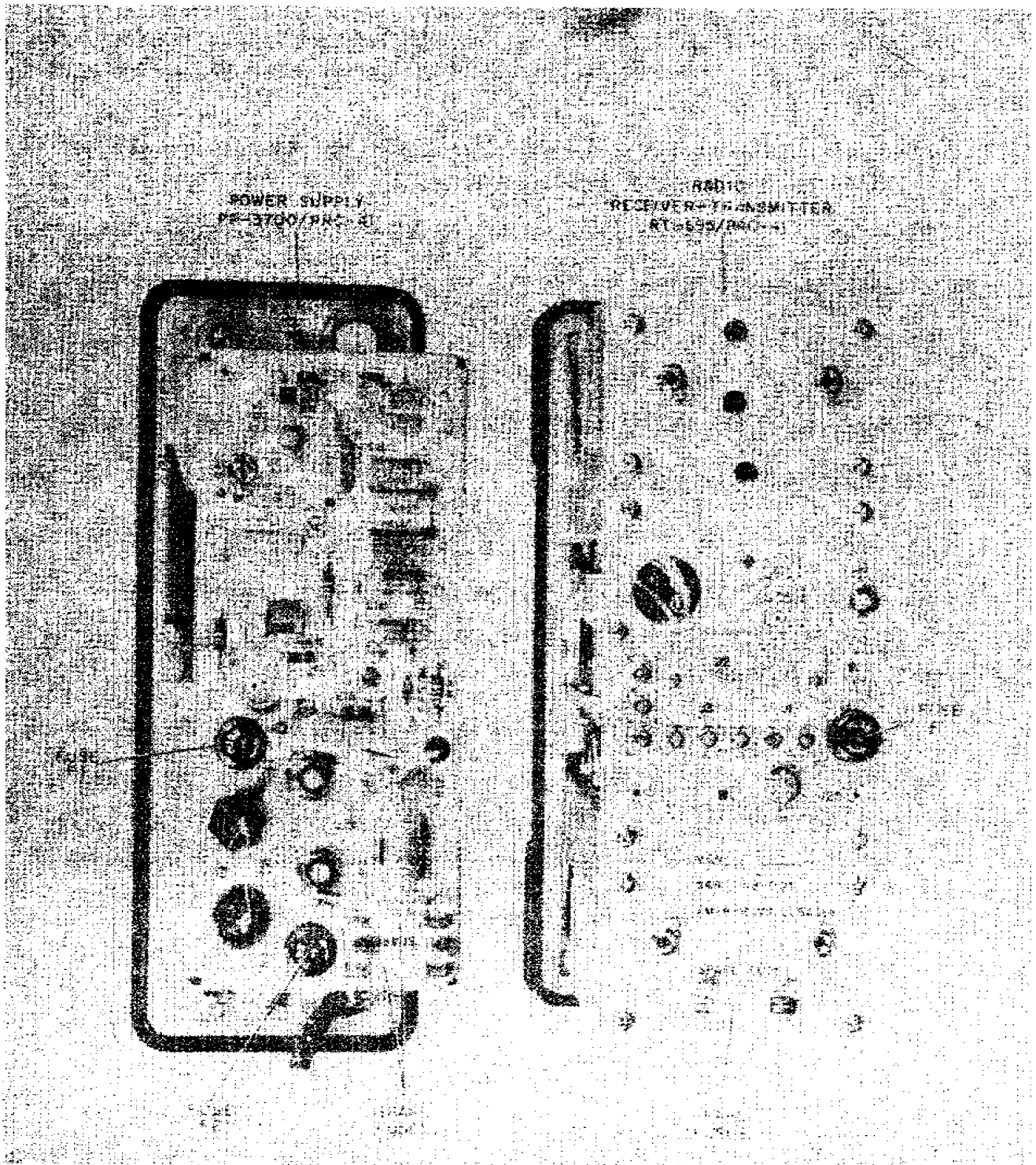

Figure 3-2. Radio Receiver-Transmitter RT-695/PRC-41, and Power Supply PP-3700/PRC-41.
Rear View. Fuse Location

SECTION 7

PREVENTIVE MAINTENANCE

7-1. PREVENTIVE MAINTENANCE INSTRUCTIONS.

Preventive maintenance is the systematic care, servicing, and inspection of equipment to prevent the occurrence of trouble, to reduce downtime, and to assure that the equipment is serviceable.

a. **SYSTEMATIC CARE.** - The procedures given in paragraphs 7-2 through 7-7 cover routine systematic care and cleaning essential to proper upkeep and operation of the equipment.

b. **PREVENTIVE MAINTENANCE CHECKS AND SERVICES.** - The preventive maintenance checks and services charts (para 7-2 and 7-6) outline functions to be performed at specific intervals. These checks and services are to maintain Army electronic equipment in a combat serviceable condition; that is, in good general (physical) condition and in good operating condition. To assist operators in maintaining combat serviceability the charts indicate what to check, how to check, and what the normal conditions are; the References column lists the illustrations, paragraphs, or manuals that contain supplementary information. If the defect cannot be remedied by the operator, higher echelon maintenance or repair is required. Records and reports of these checks and services must be made in accordance with the requirements set forth in TM 38-750.

c. **PREVENTIVE MAINTENANCE CHECKS AND SERVICES PERIODS.** - Preventive maintenance checks and services of the equipment are required daily. Subparagraph d specifies the checks and services that must be accomplished daily and under the conditions listed below.

- (1) When the equipment is initially installed.
- (2) When the equipment is reinstalled after removal for any reason.
- (3) At least once each week if the equipment is maintained in standby condition.

7-2. DAILY PREVENTIVE MAINTENANCE CHECKS AND SERVICES CHART.

Sequence No.	Item	Procedure	References
1	End item equipment	Inspect equipment for completeness	Tables 1-1, 1-2.
2	Exterior surfaces	Clean exterior surfaces, including panel. Check frequency indicator lens for cracks.	Para 7-3.
3	Connectors	Check tightness of all connectors	Fig. 1-11.
4	Controls	While making operating checks (item 5), observe that mechanical action of each knob, dial, and switch is smooth and free of external or internal binding, and that there is no excessive looseness.	Fig. 3-1.
5	Operation	Operate equipment according to paragraph 3-3. During operation, be alert for any unusual signs or conditions.	
6	Battery and	Inspect battery for loose terminals and compartment. leakage. Check compartment for corrosion.	Para 1-5b(4)(b).

7-2. DAILY PREVENTIVE MAINTENANCE CHECKS AND SERVICES CHART (cont).

Sequence No.	Item	Procedure	References
7	Antennas	When Antenna AS-1405/PRC-41 is used, check antenna elements for corrosion and looseness. See that the mast section guy wires are tight.	Fig. 1-1.
8	Canvas items	Check the harness set for mildew and tears	Fig. 1-2.
9	Cables	Check all cables for breaks and cracks	Fig. 1-11.

7-3. CLEANING.

Inspect the exterior of the equipment. The exterior surfaces should be clean, and free of dust, dirt, grease, and fungus.

a. Remove dust and loose dirt with a clean soft cloth.

Warning: Cleaning Compound (Federal stock No. 7930-395-9542) is flammable and its fumes are toxic. Provide adequate ventilation. Do not use near a flame.

b. Remove grease, fungus, and ground-in dirt from the cases; use a cloth dampened (not wet) with cleaning compound.

c. Remove dust or dirt from plugs and jacks with a brush.

d. Clean the front panel and control knobs; use a soft clean cloth. If dirt is difficult to remove dampen the cloth with water; use mild soap if necessary.

7-4. QUARTERLY MAINTENANCE.

a. Preventive maintenance is the responsibility of all echelons concerned with the equipment and includes the inspection, testing, and repair or replacement of parts, subassemblies, or units that inspection and tests indicate would probably fail before the next scheduled periodic service. Preventive maintenance checks and services of the equipment at the second echelon level are made at quarterly intervals unless otherwise directed by the commanding officer. The preventive maintenance checks and services should be scheduled concurrently with the periodic service schedule of the carrying vehicle for all vehicular installations.

b. Maintenance forms and records to be used and maintained on this equipment are specified in TM 38-750.

7-5. QUARTERLY PREVENTIVE MAINTENANCE CHECKS AND SERVICES PERIODS.

Quarterly preventive maintenance checks and services on the equipment are required. Periodic daily services constitute a part of the quarterly preventive maintenance checks and services and must be performed concurrently. All deficiencies or shortcomings will be recorded in accordance with the requirements of EM 38-750. Perform all the checks and services listed in the quarterly preventive maintenance checks and services chart (para 7-6) in the sequence listed .

7-6. QUARTERLY PREVENTIVE MAINTENANCE CHECKS AND SERVICES CHART.

Sequence No.	Item	Procedure	References
1	Publications	See that all publications are complete, serviceable, and current.	DA Pam 310-4.
2	Modifications	Check DA Pam 310-4 to determine if new applicable MWO's have been published. All URGENT MWO's must be applied immediately. All NORMAL MWO's must be scheduled.	TM 3O-750 and DA Pam 310-4.
3	Spare parts	Check spare parts (operator and organizational) for general condition and method of storage.	Para 3-4c (1) (c).
4	Installation	See that equipment is properly installed	Sect. 2.
5	Preservation	Check all surfaces for evidence of fungus. Para 7-7. Remove rust and corrosion and spot-paint bare spots	
6	Fuses	See that all operating fuses are of correct value. Check spare fuse for proper value.	Para 3-4c (1) (c).

7-6. QUARTERLY PREVENTIVE MAINTENANCE CHECKS AND SERVICES CHART (cont).

Sequence No.	Item	Procedure	References
7	Mounting	See that all bolts, nuts, and washers are correctly positioned and properly tightened. Check for cracked, bent, or broken brackets	

7-7. CLEANING AND TOUCHUP PAINTING INSTRUCTIONS.

Clean rust and corrosion from metal surfaces by lightly sanding them with fine sandpaper. Brush two thin coats of paint on the bare metal to protect it from further corrosion. Refer to the applicable cleaning and refinishing practices specified in TM 9-213.

SECTION 8

TROUBLESHOOTING

8-1. OPERATOR'S TROUBLESHOOTING.

a. **BATTERY OPERATION.**- If the AN/PRC-41 is inoperative and the pilot lamps do not light, check the fuse in the RT-695/PRC-41 (fig. 3-2). If the fuse is good, check the visual charge indicator on the side of the BB-451/U. (Refer to paragraph 2-4a(2).) A full charge is indicated by dark red in the C window and yellow or a clear color in the D window. If the C window shows yellow or clear, or the D window shows other than yellow or clear, the charge is low. If the charge is low, place the BB-451/U on charge.

b. **AC OPERATION.** If the AN/PRC-41 is inoperative and the pilot lamps do not light, check the fuse in the PP-3700/PRC-41 (fig. 3-2) in addition to the one in the RT-695/PRC-41. If the fuses are good, higher echelon repair is required.

8-2. ORGANIZATIONAL TROUBLESHOOTING.

If the BB-451/U will not take a charge, test the voltage of the cells. Each cell should indicate 1.86 volts without a load. The minimum voltage measured per cell must be not less than 1.375 volts under load. If the voltage is lower, and the BB-451 will not take a charge, it is defective and must be replaced. If the AN/PRC-41 is being operated on ac, check the ac voltage input. If it is not approximately 115 or 230 volts, and the fuse is good higher echelon repair is required.

APPENDIX
REFERENCES

Following is a list of applicable publications available to the unit repairman of Radio Set AN PRC-41.

DA Pam 310-4	Index of Technical Manuals, Technical Bulletins, Supply Manuals (Types 4, 6, 7, 8, and 9), Supply Bulletins, Lubrication Orders, and Modification Work Orders.
TM 9-213	Painting Instructions for Field Use.
TM 38-750	The Army Equipment Record System and Procedures.

TM 11-5820-510-12 (a reprint of Department of the Navy publication TM-3816A-12/1- NAVSHIPS 94756) is published for the use of Army personnel.

By Order of the Secretary of the Army:

EARLE G. WHEELER,
*General, United States Army,
Chief of Staff*

Official

J. C. LAMBERT,
*Major General, United States Army,
The Adjutant General.*

Distribution:

Active Army:

USASA (7)	USAMICOM (4)	POE (1)
CNGB (1)	USASCC (4)	AMS (1)
CSigO (7)	MDW (1)	AAF (CONUS) (2)
CofT (1)	Armies (2)	Army Pic Cen (2)
CofEngrs (1)	Corps (2)	USA Mbl Spt Cen (1)
TSG (1)	USATC FA (2)	USA Elct Mat Agcy (9)
CofSptS (1)	USATC AD (2)	Chicago Proc Dist (1)
USAECDA (1)	USATC Armor (2)	Sig Fld Maint Shops (3)
USACBRCDA (1)	USATC Engr (2)	USA Elct RD Actv, White Sands
USACECDA (1)	USATC Inf (2)	(13)
USACECDA, Ft Monmouth (1)	USASTC (2)	USAERDL Trp Comd (10)
USAMSCDA (1)	Installations (2) except	WSMR (5)
USAOCD (1)	Ft Monmouth (63)	Yuma PG (2)
USAQMCDA (1)	Ft Hancock (4)	U SA Corps (3)
USATCDA (1)	Ft Gordon (5)	Units organized under following
USAADCDA (1)	Ft Huachuca (10)	TOE's:
USAARMCDA (1)	GENDEP (OS) (2)	(2 copies each)
USAAVNCDA (1)	Sig Dep (OS) (12)	11-16
USAARTYCDA (1)	Sig Sec, GENDEP (5)	11-57
USASWCDA (1)	Army Dep (2) except	11-98
USAMC (5)	Lexington (12)	11-117
USASMCOM (1)	Sacramento (28)	11-155
USCONARC (6)	Tobyhanna (12)	11-157
ARADCOM (2)	Ft Worth (8)	11- 500 (AA-AE)
ARADCOM Rgn (2)	Svc Colleges (2)	11-557
OS Maj Comd (3)	Br Svc Sch (2)	11-587
OS Base Comd (2)	WRAMC (2)	11-592
LOGCOMD (2)	USA Trans Tml Comd (1)	11-597
USAECOM (7)	Army Tml (1)	

NG: None.

USAR: None.

For explanation Of abbreviations used, see AR 320-50.

RECOMMENDED CHANGES TO EQUIPMENT TECHNICAL PUBLICATIONS



*THEN...JOT DOWN THE
DOPE ABOUT IT ON THIS FORM.
CAREFULLY TEAR IT OUT, FOLD IT
AND DROP IT IN THE MAIL.*

SOMETHING WRONG WITH PUBLICATION

FROM: (PRINT YOUR UNIT'S COMPLETE ADDRESS)

DATE SENT

PUBLICATION NUMBER

PUBLICATION DATE

PUBLICATION TITLE

BE EXACT PIN-POINT WHERE IT IS

PAGE
NO.

PARA-
GRAPH

FIGURE
NO.

TABLE
NO.

IN THIS SPACE, TELL WHAT IS WRONG
AND WHAT SHOULD BE DONE ABOUT IT.

PRINTED NAME, GRADE OR TITLE AND TELEPHONE NUMBER

SIGN HERE

